



PRODUCT	PAGE
GENERAL:	
Warning and Safety Reminder	H-2
Stock Material Handling Products	H-3
SCREW CONVEYORS:	H-4 – H-123
Engineering Section I	H-4
Design and Layout Section II.....	H-36
Component Section III.....	H-51
Special Features Section IV	H-108
Installation and Maintenance Section V	H-121
BUCKET ELEVATORS SECTION VI:	H-124 – H-143
DRAG CONVEYOR SECTION VII:	H-144 – H-154
VERTICAL SCREW ELEVATOR SECTION VIII:	H-155 – H-164
MODULAR PLASTIC SCREW CONVEYORS SECTION IX:	H-165 - H-168
SHAFTLESS SCREW CONVEYOR SECTION X:	H-169 - H-172
DATA SHEETS:	H-173



WARNING AND SAFETY REMINDERS FOR SCREW, DRAG, AND BUCKET ELEVATOR CONVEYORS

APPROVED FOR DISTRIBUTION BY THE SCREW CONVEYOR SECTION OF THE CONVEYOR EQUIPMENT MANUFACTURERS ASSOCIATION (CEMA)

It is the responsibility of the contractor, installer, owner and user to install, maintain and operate the conveyor, components and, conveyor assemblies in such a manner as to comply with the Williams-Steiger Occupational Safety and Health Act and with all state and local laws and ordinances and the American National Standards Institute (ANSI) B20.1 Safety Code.

In order to avoid an unsafe or hazardous condition, the assemblies or parts must be installed and operated in accordance with the following minimum provisions.

- Conveyors shall not be operated unless all covers and/or guards for the conveyor and drive unit are in place. If the conveyor is to be opened for inspection cleaning, maintenance or observation, the electric power to the motor driving the conveyor must be LOCKED OUT in such a manner that the conveyor cannot be restarted by anyone; however remote from the area, until conveyor cover or guards and drive guards have been properly replaced.
- If the conveyor must have an open housing as a condition of its use and application, the entire conveyor is then to be guarded by a railing or fence in accordance with ANSI standard B20.1. (Request current edition and addenda)
- Feed openings for shovel, front loaders or other manual or mechanical equipment shall be constructed in such a way that the conveyor opening is covered by a grating. If the nature of the material is such that a grating cannot be used, then the exposed section of the conveyor is to be guarded by a railing or fence and there shall be a warning sign posted.
- Do not attempt any maintenance or repairs of the conveyor until power has been LOCKED OUT.
- Always operate conveyor in accordance with these instructions and those contained on the caution labels affixed to the equipment.
- Do not place hands, feet, or any part of your body, in the conveyor.
- Never walk on conveyor covers, grating or guards.
- Do not use conveyor for any purpose other than that for which it was intended.
- Do not poke or prod material into the conveyor with a bar or stick inserted through the openings.
- Keep area around conveyor drive and control station free of debris and obstacles.
- Eliminate all sources of stored energy (materials or devices that could cause conveyor components to move without power applied) before opening the conveyor
- Do not attempt to clear a jammed conveyor until power has been LOCKED OUT.
- Do not attempt field modification of conveyor or components.
- Conveyors are not normally manufactured or designed to handle materials that are hazardous to personnel. These materials which are hazardous include those that are explosive, flammable, toxic or otherwise dangerous to personnel. Conveyors may be designed to handle these materials. Conveyors are not manufactured or designed to comply with local, state or federal codes for unfired pressure vessels. If hazardous materials are to be conveyed or if the conveyor is to be subjected to internal or external pressure, manufacturer should be consulted prior to any modifications.

blers as we have no information regarding plant wiring, plant environment, the interlocking of the screw conveyor with other equipment, extent of plant automation, etc. Other devices should not be used as a substitute for locking out the power prior to removing guards or covers. We caution that use of the secondary devices may cause employees to develop a false sense of security and fail to lock out power before removing covers or guards. This could result in a serious injury should the secondary device fail or malfunction.

There are many kinds of electrical devices for interlocking of conveyors and conveyor systems such that if one conveyor in a system or process is stopped other equipment feeding it, or following it can also be automatically stopped.

Electrical controls, machinery guards, railings, walkways, arrangement of installation, training of personnel, etc., are necessary ingredients for a safe working place. It is the responsibility of the contractor, installer, owner and user to supplement the materials and services furnished with these necessary items to make the conveyor installation comply with the law and accepted standards.

Conveyor inlet and discharge openings are designed to connect to other equipment or machinery so that the flow of material into and out of the conveyor is completely enclosed.

One or more warning labels should be visible on conveyor housings, conveyor covers and elevator housings. If the labels attached to the equipment become illegible, please order replacement warning labels from the OEM or CEMA.

The Conveyor Equipment Manufacturers Association (CEMA) has produced an audio-visual presentation entitled "Safe Operation of Screw Conveyors, Drag Conveyors, and Bucket Elevators." CEMA encourages acquisition and use of this source of safety information to supplement your safety program.

CONVEYORS



PROMINENTLY DISPLAY THESE SAFETY LABELS ON INSTALLED EQUIPMENT

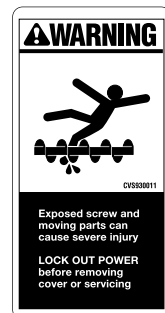
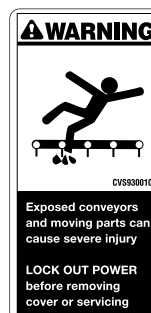

NOTICE: This document is provided by CEMA as a service to the industry in the interest of promoting safety. It is advisory only and it is not a substitute for a thorough safety program. Users should consult with qualified engineers and other safety professionals. CEMA makes no representations or warranties, either expressed or implied, and the users of this document assume full responsibility for the safe design and operation of equipment.



Stock & MTO Screw Conveyor Components

Screw Conveyor Components and Accessories



ANGLE FLANGED "U" TROUGH



FORM FLANGED "U" TROUGH



SECTIONAL SCREWS



SPECIALS



TUBULAR HOUSING



FLAT RACK AND PINION DISCHARGE GATE



TROUGH ENDS WITH AND WITHOUT FEET



SECTIONAL FLIGHTS



COUPLING SHAFTS



ELEVATOR BUCKETS



THRUST ASSEMBLY TYPE E WITH DRIVE SHAFT



INLETS AND DISCHARGE SPOUTS DISCHARGE



SPLIT GLAND



HANGER STYLE 220



HANGER STYLE 226



HANGER STYLE 216



PACKING GLAND SHAFT SEAL COMPRESSION TYPE



WASTE PACK SHAFT SEAL



PLATE SHAFT SEAL



DROP-OUT SHAFT SEAL FLANGED PRODUCT



HANGER STYLE 70



HANGER STYLE 19B



TROUGH END BEARINGS BALL AND ROLLER



HELICOID SCREWS



HELICOID FLIGHTING RIGHT HAND AND LEFT HAND



HANGER BEARINGS STYLE 220/226

Martin HARD IRON
Martin BRONZE
NYLATRON
WHITE NYLON
WOOD
CERAMIC



SADDLES AND FEET

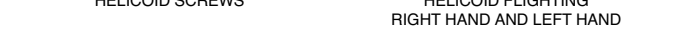

HELICOID SCREWS

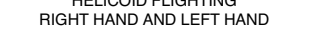

HELICOID FLIGHTING RIGHT HAND AND LEFT HAND



SCREW CONVEYOR DRIVE WITH ACCESSORIES

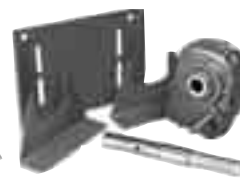

SPEED REDUCER SHAFT MOUNTED WITH ACCESSORIES.



FLANGED COVER WITH ACCESSORIES

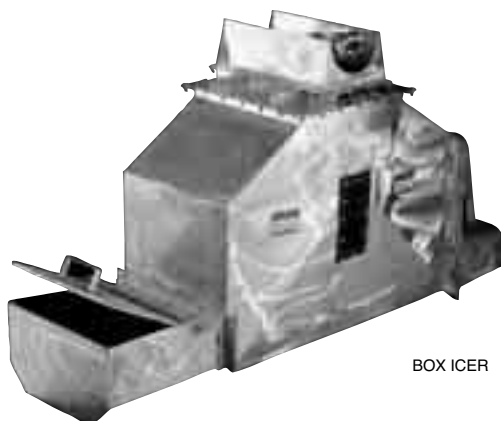

BOX ICER

Martin manufacturers the most complete line of stock components in the industry. We stock mild steel, stainless, galvanized, and many other items that are "special order" from the others in the industry.

SECTION I

ENGINEERING SECTION I

Introduction to Engineering Section	H-4
Screw Conveyor Design Procedure	H-5
Material Classification Code Chart	H-6
Material Characteristics Tables	H-7
Selection of Conveyor Size and Speed	H-17
Capacity Factor Tables.....	H-18
Capacity Table	H-19
Lump Size Limitations and Table	H-20
Component Group Selection.....	H-21
Hanger Bearing Selection	H-23
Horsepower Calculation.....	H-24
Torsional Ratings of Conveyor Components	H-27
Horsepower Ratings of Conveyor Components	H-28
Screw Conveyor End Thrust and Thermal Expansion	H-29
Screw Conveyor Deflection.....	H-30
Inclined and Vertical Screw Conveyors	H-32
Screw Feeders	H-33

Introduction

The following section is designed to present the necessary engineering information to properly design and layout most conveyor applications. The information has been compiled from many years of experience in successful design and application and from industry standards.

We hope that the information presented will be helpful to you in determining the type and size of screw conveyor that will best suit your needs.

The “Screw Conveyor Design Procedure” on the following page gives ten step-by-step instructions for properly designing a screw conveyor. These steps, plus the many following tables and formulas throughout the engineering section will enable you to design and detail screw conveyor for most applications.

If your requirements present any complications not covered in this section, we invite you to contact our Engineering Department for recommendations and suggestions.

SCREW CONVEYOR DESIGN PROCEDURE

SCREW CONVEYOR DESIGN PROCEDURE		
STEP 1	Establish Known Factors	<ol style="list-style-type: none"> 1. Type of material to be conveyed. 2. Maximum size of hard lumps. 3. Percentage of hard lumps by volume. 4. Capacity required, in cu.ft./hr. 5. Capacity required, in lbs./hr. 6. Distance material to be conveyed. 7. Any additional factors that may affect conveyor or operations.
STEP 2	Classify Material	Classify the material according to the system shown in Table 1-1. Or, if the material is included in Table 1-2, use the classification shown in Table 1-2.
STEP 3	Determine Design Capacity	Determine design capacity as described on pages H-17–H-19.
STEP 4	Determine Diameter and Speed	Using known capacity required in cu.ft./hr., material classification, and % trough loading (Table 1-2) determine diameter and speed from Table 1-6.
STEP 5	Check Minimum Screw Diameter for Lump Size Limitations	Using known screw diameter and percentage of hard lumps, check minimum screw diameter from Table 1-7.
STEP 6	Determine Type of Bearings	From Table 1-2, determine hanger bearing group for the material to be conveyed. Locate this bearing group in Table 1-11 for the type of bearing recommended.
STEP 7	Determine Horsepower	From Table 1-2, determine Horsepower Factor “F _m ” for the material to be conveyed. Refer to page H-24 and calculate horsepower by the formula method.
STEP 8	Check Torsional and/or Horsepower ratings of Standard Conveyor Components	Using required horsepower from step 7 refer to pages H-27 and H-28 to check capacities of standard conveyor pipe, shafts and coupling bolts.
STEP 9	Select Components	Select basic components from Tables 1-8, 1-9, and 1-10 in accordance with Component Group listed in Table 1-2 for the material to be conveyed. Select balance of components from the Components Section of catalogue.
STEP 10	Conveyor Layouts	Refer to pages H-40 and H-41 for typical layout details.

Table 1-1 Material Classification Code Chart



Major Class	Material Characteristics Included	Code Designation
Density	Bulk Density, Loose	Actual Lbs/PC
Size	Very Fine No. 200 Sieve (.0029") And Under No. 100 Sieve (.0059") And Under No. 40 Sieve (.016") And Under	A ₂₀₀ A ₁₀₀ A ₄₀
	Fine No. 6 Sieve (.132") And Under	B ₆
	Granular ½" And Under (6 Sieve to ½") 3" And Under (½ to 3") 7" And Under (3" to 7")	C _½ D ₃ D ₇
	Lumpy 16" And Under (0" to 16") Over 16" To Be Specified X=Actual Maximum Size	D ₁₆ D _X
	Irregular Stringy, Fibrous, Cylindrical, Slabs, Etc.	E
Flowability	Very Free Flowing	1
	Free Flowing	2
	Average Flowability	3
	Sluggish	4
Abrasiveness	Mildly Abrasive	5
	Moderately Abrasive	6
	Extremely Abrasive	7
Miscellaneous Properties Or Hazards	Builds Up and Hardens	F
	Generates Static Electricity	G
	Decomposes — Deteriorates in Storage	H
	Flammability	J
	Becomes Plastic or Tends to Soften	K
	Very Dusty	L
	Aerates and Becomes a Fluid	M
	Explosiveness	N
	Stickiness — Adhesion	O
	Contaminable, Affecting Use	P
	Degradable, Affecting Use	Q
	Gives Off Harmful or Toxic Gas or Fumes	R
	Highly Corrosive	S
	Mildly Corrosive	T
	Hygroscopic	U
	Interlocks, Mats or Agglomerates	V
	Oils Present	W
Packs Under Pressure	X	
Very Light and Fluffy — May Be Windswept	Y	
Elevated Temperature	Z	

Table 1-2 Material Characteristics



Material	Weight lbs. per cu. ft.	Intermediate Material Code	Bearing Selection	Component Series	Mat'l Factor Fm	Trough Loading
Adipic Acid	45	A 100-35	S	2	.5	30A
Alfalfa Meal	14-22	B6-45WY	H	2	.6	30A
Alfalfa Pellets	41-43	C½-25	H	2	.5	45
Alfalfa Seed	6 10-15	B6-15N	L-S-B	1	.4	45
Almonds, Broken	27-30	C½-35Q	H	2	.9	30A
Almonds, Whole Shelled	28-30	C½-35Q	H	2	.9	30A
Alum, Fine	45-50	B6-35U	L-S-B	1	.6	30A
Alum, Lumpy	50-60	B6-25	L-S	2	1.4	45
Alumina	55-65	B6-27MY	H	3	1.8	15
Alumina, Fine	35	A100-27MY	H	3	1.6	15
Alumina Sized Or Briquette	65	D3-37	H	3	2.0	15
Aluminate Gel (Aluminate Hydroxide)	45	B6-35	H	2	1.7	30A
Aluminum Chips, Dry	7-15	E-45V	H	2	1.2	30A
Aluminum Chips, Oily	7-15	E-45V	H	2	.8	30A
Aluminum Hydrate	13-20	C½-35	L-S-B	1	1.4	30A
Aluminum Ore (See Bauxite)	—	—	—	—	—	—
Aluminum Oxide	60-120	A100-17M	H	3	1.8	15
Aluminum Silicate (Andalusite)	49	C½-35S	L-S	3	.8	30A
Aluminum Sulfate	45-58	C½-25	L-S-B	1	1.0	45
Ammonium Chloride, Crystalline	45-52	A100-45FRS	L-S	3	.7	30A
Ammonium Nitrate	45-62	A40-35NTU	H	3	1.3	30A
Ammonium Sulfate	45-58	C½-35FOTU	L-S	1	1.0	30A
Antimony Powder	—	A100-35	H	2	1.6	30A
Apple Pomace, Dry	15	C½-45Y	H	2	1.0	30A
Arsenate Of Lead (See Lead Arsenate)	—	—	—	—	—	—
Arsenic Oxide (Arsenolite)	100-120	A100-35R	L-S-B	—	—	30A
Arsenic Pulverized	30	A100-25R	H	2	.8	45
Asbestos — Rock (Ore)	81	D3-37R	H	3	1.2	15
Asbestos — Shredded	20-40	E-46XY	H	2	1.0	30B
Ash, Black Ground	105	B6-35	L-S-B	1	2.0	30A
Ashes, Coal, Dry — ½"	35-45	C½-46TY	H	3	3.0	30B
Ashes, Coal, Dry — 3"	35-40	D3-46T	H	3	2.5	30B
Ashes, Coal, Wet — ½"	45-50	C½-46T	H	3	3.0	30B
Ashes, Coal, Wet — 3"	45-50	D3-46T	H	3	4.0	30B
Ashes, Fly (See Fly Ash)	—	—	—	—	—	—
Asphalt, Crushed — ½"	45	C½-45	H	2	2.0	30A
Bagasse	7-10	E-45RVXY	L-S-B	2	1.5	30A
Bakelite, Fine	30-45	B6-25	L-S-B	1	1.4	45
Baking Powder	40-55	A100-35	S	1	.6	30A
Baking Soda (Sodium Bicarbonate)	40-55	A100-25	S	1	.6	45
Barite (Barium Sulfate) + ½" — 3"	120-180	D3-36	H	3	2.6	30B
Barite, Powder	120-180	A100-35X	H	2	2.0	30A
Barium Carbonate	72	A100-45R	H	2	1.6	30A
Bark, Wood, Refuse	10-20	E-45TVY	H	3	2.0	30A
Barley, Fine, Ground	24-38	B6-35	L-S-B	1	.4	30A
Barley, Malted	31	C½-35	L-S-B	1	.4	30A
Barley, Meal	28	C½-35	L-S-B	1	.4	30A
Barley, Whole	36-48	B6-25N	L-S-B	1	.5	45
Basalt	80-105	B6-27	H	3	1.8	15
Bauxite, Dry, Ground	68	B6-25	H	2	1.8	45
Bauxite, Crushed — 3"	75-85	D3-36	H	3	2.5	30B
Beans, Castor, Meal	35-40	B6-35W	L-S-B	1	.8	30A
Beans, Castor, Whole Shelled	36	C½-15W	L-S-B	1	.5	45
Beans, Navy, Dry	48	C½-15	L-S-B	1	.5	45
Beans, Navy, Steeped	60	C½-25	L-S-B	1	.8	45

Material	Weight lbs. per cu. ft.	Intermediate Material Code	Bearing Selection	Component Series	Mat'l Factor Fm	Trough Loading
Bentonite, Crude	34-40	D3-45X	H	2	1.2	30A
Bentonite, -100 Mesh	50-60	A100-25MXY	H	2	.7	45
Benzene Hexachloride	56	A100-45R	L-S-B	1	.6	30A
Bicarbonate of Soda (Baking Soda)	—	—	S	1	.6	—
Blood, Dried	35-45	D3-45U	H	2	2.0	30A
Blood, Ground, Dried	30	A100-35U	L-S	1	1.0	30A
Bone Ash (Tricalcium Phosphate)	40-50	A100-45	L-S	1	1.6	30A
Boneblack	20-25	A100-25Y	L-S	1	1.5	45
Bonechar	27-40	B6-35	L-S	1	1.6	30A
Bonemeal	50-60	B6-35	H	2	1.7	30A
Bones, Whole*	35-50	E-45V	H	2	3.0	30A
Bones, Crushed	35-50	D3-45	H	2	2.0	30A
Bones, Ground	50	B6-35	H	2	1.7	30A
Borate of Lime	60	A100-35	L-S-B	1	.6	30A
Borax, Fine	45-55	B6-25T	H	3	.7	30B
Borax Screening — ½"	55-60	C½-35	H	2	1.5	30A
Borax, 1½"-2" Lump	55-60	D3-35	H	2	1.8	30A
Borax, 2"-3" Lump	60-70	D3-35	H	2	2.0	30A
Boric Acid, Fine	55	B6-25T	H	3	.8	30A
Boron	75	A100-37	H	2	1.0	30B
Bran, Rice — Rye — Wheat	16-20	B6-35NY	L-S-B	1	.5	30A
Braunite (Manganese Oxide)	120	A100-36	H	2	2.0	30B
Bread Crumbs	20-25	B6-35PQ	L-S-B	1	.6	30A
Brewer's Grain, Spent, Dry	14-30	C½-45	L-S-B	1	.5	30A
Brewer's Grain, Spent, Wet	55-60	C½-45T	L-S	2	.8	30A
Brick, Ground — ½"	100-120	B6-37	H	3	2.2	15
Bronze Chips	30-50	B6-45	H	2	2.0	30A
Buckwheat	37-42	B6-25N	L-S-B	1	.4	45
Calcine, Flour	75-85	A100-35	L-S-B	1	.7	30A
Calcium Carbide	70-90	D3-25N	H	2	2.0	30A
Calcium Carbonate (See Limestone)	—	—	—	—	—	—
Calcium Fluoride (See Fluorspar)	—	—	—	—	—	—
Calcium Hydrate (See Lime, Hydrated)	—	—	—	—	—	—
Calcium Hydroxide (See Lime, Hydrated)	—	—	—	—	—	—
Calcium Lactate	26-29	D3-45QTR	L-S	2	.6	30A
Calcium Oxide (See Lime, Unslaked)	—	—	—	—	—	—
Calcium Phosphate	40-50	A100-45	L-S-B	1	1.6	30A
Calcium Sulfate (See Gypsum)	—	—	—	—	—	—
Carbon, Activated, Dry Fine*	—	—	—	—	—	—
Carbon Black, Pelleted*	—	—	—	—	—	—
Carbon Black, Powder*	—	—	—	—	—	—
Carborundum	100	D3-27	H	3	3.0	15
Casein	36	B6-35	H	2	1.6	30A
Cashew Nuts	32-37	C½-45	H	2	.7	30A
Cast Iron, Chips	130-200	C½-45	H	2	4.0	30A
Caustic Soda	88	B6-35RSU	H	3	1.8	30A
Caustic Soda, Flakes	47	C½-45RSUX	L-S	3	1.5	30A
Celite (See Diatomaceous Earth)	—	—	—	—	—	—
Cement, Clinker	75-95	D3-36	H	3	1.8	30B
Cement, Mortar	133	B6-35Q	H	3	3.0	30A
Cement, Portland	94	A100-26M	H	2	1.4	30B
Cement, Aerated (Portland)	60-75	A100-16M	H	2	1.4	30B
Cerrusite (See Lead Carbonate)	—	—	—	—	—	—
Chalk, Crushed	75-95	D3-25	H	2	1.9	30A
Chalk, Pulverized	67-75	A100-25MXY	H	2	1.4	45
Charcoal, Ground	18-28	A100-45	H	2	1.2	30A

Table 1-2 Material Characteristics (Cont'd)



Material	Weight lbs. per cu. ft.	Intermediate Material Code	Bearing Selection	Component Series	Mat'l Factor Fm	Trough Loading
Charcoal, Lumps	18-28	D3-45Q	H	2	1.4	30A
Chocolate, Cake Pressed	40-45	D3-25	S	2	1.5	30A
Chrome Ore	125-140	D3-36	H	3	2.5	30B
Cinders, Blast Furnace	57	D3-36T	H	3	1.9	30B
Cinders, Coal	40	D3-36T	H	3	1.8	30B
Clay (See Bentonite, Diatomaceous Earth, Fuller's Earth, Kaolin & Marl)	—	—	—	—	—	—
Clay, Ceramic, Dry, Fines	60-80	A100-35P	L-S-B	1	1.5	30A
Clay, Calcined	80-100	B6-36	H	3	2.4	30B
Clay, Brick, Dry, Fines	100-120	C½-36	H	3	2.0	30B
Clay, Dry, Lumpy	60-75	D3-35	H	2	1.8	30A
Clinker, Cement (See Cement Clinker)	—	—	—	—	—	—
Clover Seed	45-48	B6-25N	L-S-B	1	.4	45
Coal, Anthracite (River & Culm)	55-61	B6-35TY	L-S	2	1.0	30A
Coal, Anthracite, Sized-½"	49-61	C½-25	L-S	2	1.0	45
Coal, Bituminous, Mined	40-60	D3-35LNXY	L-S	1	.9	30A
Coal, Bituminous, Mined, Sized	45-50	D3-35QV	L-S	1	1.0	30A
Coal, Bituminous, Mined, Slack	43-50	C½-45T	L-S	2	.9	30A
Coal, Lignite	37-45	D3-35T	H	2	1.0	30A
Cocoa Beans	30-45	C½-25Q	L-S	1	.5	45
Cocoa, Nibs	35	C½-25	H	2	.5	45
Cocoa, Powdered	30-35	A100-45XY	S	1	.9	30A
Cocoanut, Shredded	20-22	E-45	S	2	1.5	30A
Coffee, Chaff	20	B6-25MY	L-S	1	1.0	45
Coffee, Green Bean	25-32	C½-25PQ	L-S	1	.5	45
Coffee, Ground, Dry	25	A40-35P	L-S	1	.6	30A
Coffee, Ground, Wet	35-45	A40-45X	L-S	1	.6	30A
Coffee, Roasted Bean	20-30	C½-25PQ	S	1	.4	45
Coffee, Soluble	19	A40-35PUY	S	1	.4	45
Coke, Breeze	25-35	C½-37	H	3	1.2	15
Coke, Loose	23-35	D7-37	H	3	1.2	15
Coke, Petrol, Calcined	35-45	D7-37	H	3	1.3	15
Compost	30-50	D7-45TV	L-S	3	1.0	30A
Concrete, Pre-Mix Dry	85-120	C½-36U	H	3	3.0	30B
Copper Ore	120-150	DX-36	H	3	4.0	30B
Copper Ore, Crushed	100-150	D3-36	H	3	4.0	30B
Copper Sulphate, (Bluestone)	75-95	C½-35S	L-S	2	1.0	30A
Copperas (See Ferrous Sulphate)	—	—	—	—	—	—
Copra, Cake Ground	40-45	B6-45HW	L-S-B	1	.7	30A
Copra, Cake, Lumpy	25-30	D3-35HW	L-S-B	2	.8	30A
Copra, Lumpy	22	E-35HW	L-S-B	2	1.0	30A
Copra, Meal	40-45	B6-35HW	H	2	.7	30A
Cork, Fine Ground	5-15	B6-35JNY	L-S-B	1	.5	30A
Cork, Granulated	12-15	C½-35JY	L-S-B	1	.5	30A
Corn, Cracked	40-50	B6-25P	L-S-B	1	.7	45
Corn Cobs, Ground	17	C½-25Y	L-S-B	1	.6	45
Corn Cobs, Whole*	12-15	E-35	L-S	2		30A
Corn Ear*	56	E-35	L-S	2		30A
Corn Germ	21	B6-35PY	L-S-B	1	.4	30A
Corn Grits	40-45	B6-35P	L-S-B	1	.5	30A
Cornmeal	32-40	B6-35P	L-S	1	.5	30A
Corn Oil, Cake	25	D7-45HW	L-S	1	.6	30A
Corn Seed	45	C½-25PQ	L-S-B	1	.4	45
Corn Shelled	45	C½-25	L-S-B	1	.4	45
Corn Sugar	30-35	B6-35PU	S	1	1.0	30A
Cottonseed, Cake, Crushed	40-45	C½-45HW	L-S	1	1.0	30A

Material	Weight lbs. per cu. ft.	Intermediate Material Code	Bearing Selection	Component Series	Mat'l Factor Fm	Trough Loading
Cottonseed, Cake, Lumpy	40-45	D7-45HW	L-S	2	1.0	30A
Cottonseed, Dry, Delinted	22-40	C½-25X	L-S	1	.6	45
Cottonseed, Dry, Not Delinted	18-25	C½-45XY	L-S	1	.9	30A
Cottonseed, Flakes	20-25	C½-35HWY	L-S	1	.8	30A
Cottonseed, Hulls	12	B6-35Y	L-S	1	.9	30A
Cottonseed, Meal, Expeller	25-30	B6-45HW	L-S	3	.5	30A
Cottonseed, Meal, Extracted	35-40	B6-45HW	L-S	1	.5	30A
Cottonseed, Meats, Dry	40	B6-35HW	L-S	1	.6	30A
Cottonseed, Meats, Rolled	35-40	C½-45HW	L-S	1	.6	30A
Cracklings, Crushed	40-50	D3-45HW	L-S-B	2	1.3	30A
Cryolite, Dust	75-90	A100-36L	H	2	2.0	30B
Cryolite, Lumpy	90-110	D16-36	H	2	2.1	30B
Cullet, Fine	80-120	C½-37	H	3	2.0	15
Cullet, Lump	80-120	D16-37	H	3	2.5	15
Culm, (See Coal, Anthracite)	—	—	—	—	—	—
Cupric Sulphate (Copper Sulfate)	—	—	—	—	—	—
Detergent (See Soap Detergent)	—	—	—	—	—	—
Diatomaceous Earth	11-17	A40-36Y	H	3	1.6	30B
Dicalcium Phosphate	40-50	A40-35	L-S-B	1	1.6	30A
Disodium Phosphate	25-31	A40-35	H	3	.5	30A
Distiller's Grain, Spent Dry	30	B6-35	H	2	.5	30A
Distiller's Grain, Spent Wet	40-60	C½-45V	L-S	3	.8	30A
Dolomite, Crushed	80-100	C½-36	H	2	2.0	30B
Dolomite, Lumpy	90-100	DX-36	H	2	2.0	30B
Earth, Loam, Dry, Loose	76	C½-36	H	2	1.2	30B
Ebonite, Crushed	63-70	C½-35	L-S-B	1	.8	30A
Egg Powder	16	A40-35MPY	S	1	1.0	30A
Epsom Salts (Magnesium Sulfate)	40-50	A40-35U	L-S-B	1	.8	30A
Feldspar, Ground	65-80	A100-37	H	2	2.0	15
Feldspar, Lumps	90-100	D7-37	H	2	2.0	15
Feldspar, Powder	100	A200-36	H	2	2.0	30B
Feldspar, Screenings	75-80	C½-37	H	2	2.0	15
Ferrous Sulfide — ½"	120-135	C½-26	H	2	2.0	30B
Ferrous Sulfide — 100M	105-120	A100-36	H	2	2.0	30B
Ferrous Sulphate	50-75	C½-35U	H	2	1.0	30A
Fish Meal	35-40	C½-45HP	L-S-B	1	1.0	30A
Fish Scrap	40-50	D7-45H	L-S-B	2	1.5	30A
Flaxseed	43-45	B6-35X	L-S-B	1	.4	30A
Flaxseed Cake (Linseed Cake)	48-50	D7-45W	L-S	2	.7	30A
Flaxseed Meal (Linseed Meal)	25-45	B6-45W	L-S	1	.4	30A
Flour Wheat	33-40	A40-45LP	S	1	.6	30A
Flue Dust, Basic Oxygen Furnace	45-60	A40-36LM	H	3	3.5	30B
Flue Dust, Blast Furnace	110-125	A40-36	H	3	3.5	30B
Flue Dust, Boiler H. Dry	30-45	A40-36LM	H	3	2.0	30B
Fluorspar, Fine (Calcium Fluoride)	80-100	B6-36	H	2	2.0	30B
Fluorspar, Lumps	90-110	D7-36	H	2	2.0	30B
Fly Ash	30-45	A40-36M	H	3	2.0	30B
Foundry Sand, Dry (See Sand)	—	—	—	—	—	—
Fuller's Earth, Dry, Raw	30-40	A40-25	H	2	2.0	15
Fuller's Earth, Oily, Spent	60-65	C½-450W	H	3	2.0	30A
Fuller's Earth, Calcined	40	A100-25	H	3	2.0	15
Galena (See Lead Sulfide)	—	—	—	—	—	—
Gelatine, Granulated	32	B6-35PU	S	1	.8	30A
Gilsonite	37	C½-35	H	3	1.5	30A
Glass, Batch	80-100	C½-37	H	3	2.5	15
Glue, Ground	40	B6-45U	H	2	1.7	30A

Table 1-2 Material Characteristics (Cont'd)

Material	Weight lbs. per cu. ft.	Intermediate Material Code	Bearing Selection	Component Series	Mat'l Factor Fm	Trough Loading
Glue, Pearl	40	C½-35U	L-S-B	1	.5	30A
Glue, Veg. Powdered	40	A40-45U	L-S-B	1	.6	30A
Gluten, Meal	40	B6-35P	L-S	1	.6	30A
Granite, Fine	80-90	C½-27	H	3	2.5	15
Grape Pomace	15-20	D3-45U	H	2	1.4	30A
Graphite Flake	40	B6-25LP	L-S-B	1	.5	45
Graphite Flour	28	A100-35LMP	L-S-B	1	.5	30A
Graphite Ore	65-75	DX-35L	H	2	1.0	30A
Guano Dry*	70	C½-35	L-S	3	2.0	30A
Gypsum, Calcined	55-60	B6-35U	H	2	1.6	30A
Gypsum, Calcined, Powdered	60-80	A100-35U	H	2	2.0	30A
Gypsum, Raw — 1"	70-80	D3-25	H	2	2.0	30A
Hay, Chopped*	8-12	C½-35JY	L-S	2	1.6	30A
Hexanedioic Acid (See Adipic Acid)	—	—	—	—	—	—
Hominy, Dry	35-50	C½-25	L-S-B	1	.4	45
Hops, Spent, Dry	35	D3-35	L-S-B	2	1.0	30A
Hops, Spent, Wet	50-55	D3-45V	L-S	2	1.5	30A
Ice, Crushed	35-45	D3-35Q	L-S	2	.4	30A
Ice, Flaked*	40-45	C½-35Q	S	1	.6	30A
Ice, Cubes	33-35	D3-35Q	S	1	.4	30A
Ice, Shell	33-35	D3-45Q	S	1	.4	30A
Ilmenite Ore	140-160	D3-37	H	3	2.0	15
Iron Ore Concentrate	120-180	A40-37	H	3	2.2	15
Iron Oxide Pigment	25	A100-36LMP	H	2	1.0	30B
Iron Oxide, Millscale	75	C½-36	H	2	1.6	30B
Iron Pyrites (See Ferrous Sulfide)	—	—	—	—	—	—
Iron Sulphate (See Ferrous Sulfate)	—	—	—	—	—	—
Iron Sulfide (See Ferrous Sulfide)	—	—	—	—	—	—
Iron Vitriol (See Ferrous Sulfate)	—	—	—	—	—	—
Kafir (Corn)	40-45	C½-25	H	3	.5	45
Kaolin Clay	63	D3-25	H	2	2.0	30A
Kaolin Clay-Talc	32-56	A40-35LMP	H	2	2.0	30A
Kryolith (See Cryolite)	—	—	—	—	—	—
Lactose	32	A40-35PU	S	1	.6	30A
Lamp Black (See Carbon Black)	—	—	—	—	—	—
Lead Arsenate	72	A40-35R	L-S-B	1	1.4	30A
Lead Arsenite	72	A40-35R	L-S-B	1	1.4	30A
Lead Carbonate	240-260	A40-35R	H	2	1.0	30A
Lead Ore — ¼"	200-270	B6-35	H	3	1.4	30A
Lead Ore — ½"	180-230	C½-36	H	3	1.4	30B
Lead Oxide (Red Lead) — 100 Mesh	30-150	A100-35P	H	2	1.2	30A
Lead Oxide (Red Lead) — 200 Mesh	30-180	A200-35LP	H	2	1.2	30A
Lead Sulphide — 100 Mesh	240-260	A100-35R	H	2	1.0	30A
Lignite (See Coal Lignite)	—	—	—	—	—	—
Limanite, Ore, Brown	120	C½-47	H	3	1.7	15
Lime, Ground, Unslaked	60-65	B6-35U	L-S-B	1	.6	30A
Lime Hydrated	40	B6-35LM	H	2	.8	30A
Lime, Hydrated, Pulverized	32-40	A40-35LM	L-S	1	.6	30A
Lime, Pebble	53-56	C½-25HU	L-S	2	2.0	45
Limestone, Agricultural	68	B6-35	H	2	2.0	30A
Limestone, Crushed	85-90	DX-36	H	2	2.0	30B
Limestone, Dust	55-95	A40-46MY	H	2	1.6-2.0	30B
Lindane (Benzene Hexachloride)	—	—	—	—	—	—
Linseed (See Flaxseed)	—	—	—	—	—	—
Litharge (Lead Oxide)	—	—	—	—	—	—
Lithopone	45-50	A325-35MR	L-S	1	1.0	30A

Material	Weight lbs. per cu. ft.	Intermediate Material Code	Bearing Selection	Component Series	Mat'l Factor Fm	Trough Loading
Maize (See Milo)	—	—	—	—	—	—
Malt, Dry, Ground	20-30	B6-35NP	L-S-B	1	.5	30A
Malt, Meal	36-40	B6-25P	L-S-B	1	.4	45
Malt, Dry Whole	20-30	C½-35N	L-S-B	1	.5	30A
Malt, Sprouts	13-15	C½-35P	L-S-B	1	.4	30A
Magnesium Chloride (Magnesite)	33	C½-45	L-S	1	1.0	30A
Manganese Dioxide*	70-85	A100-35NRT	L-S	2	1.5	30A
Manganese Ore	125-140	DX-37	H	3	2.0	15
Manganese Oxide	120	A100-36	H	2	2.0	30B
Manganese Sulfate	70	C½-37	H	3	2.4	15
Marble, Crushed	80-95	B6-37	H	3	2.0	15
Marl, (Clay)	80	DX-36	H	2	1.6	30B
Meat, Ground	50-55	E-45HQTX	L-S	2	1.5	30A
Meat, Scrap (Wbone)	40	E-46H	H	2	1.5	30B
Mica, Flakes	17-22	B6-16MY	H	2	1.0	30B
Mica, Ground	13-15	B6-36	H	2	.9	30B
Mica, Pulverized	13-15	A100-36M	H	2	1.0	30B
Milk, Dried, Flake	5-6	B6-35PUY	S	1	.4	30A
Milk, Malted	27-30	A40-45PX	S	1	.9	30A
Milk, Powdered	20-45	B6-25PM	S	1	.5	45
Milk Sugar	32	A100-35PX	S	1	.6	30A
Milk, Whole, Powdered	20-36	B6-35PUX	S	1	.5	30A
Mill Scale (Steel)	120-125	E-46T	H	3	3.0	30B
Milo, Ground	32-36	B6-25	L-S-B	1	.5	45
Milo Maize (Kafir)	40-45	B6-15N	L-S-B	1	.4	45
Molybdenite Powder	107	B6-26	H	2	1.5	30B
Monosodium Phosphate	50	B6-36	H	2	.6	30B
Mortar, Wet*	150	E-46T	H	3	3.0	30B
Mustard Seed	45	B6-15N	L-S-B	1	.4	45
Naphthalene Flakes	45	B6-35	L-S-B	1	.7	30A
Niacin (Nicotinic Acid)	35	A40-35P	H	2	2.5	30A
Oats	26	C½-25MN	L-S-B	1	.4	45
Oats, Crimped	19-26	C½-35	L-S-B	1	.5	30A
Oats, Crushed	22	B6-45NY	L-S-B	1	.6	30A
Oats, Flour	35	A100-35	L-S-B	1	.5	30A
Oat Hulls	8-12	B6-35NY	L-S-B	1	.5	30A
Oats, Rolled	19-24	C½-35NY	L-S-B	1	.6	30A
Oleo Margarine (Margarine)	59	E-45HKPWX	L-S	2	.4	30A
Orange Peel, Dry	15	E-45	L-S	2	1.5	30A
Oxalic Acid Crystals — Ethane Diacid Crystals	60	B6-35QS	L-S	1	1.0	30A
Oyster Shells, Ground	50-60	C½-36T	H	3	1.6-2.0	30B
Oyster Shells, Whole	80	D3-36TV	H	3	2.1-2.5	30B
Paper Pulp (4% or less)	62	E-45	L-S	2	1.5	30A
Paper Pulp (6% to 15%)	60-62	E-45	L-S	2	1.5	30A
Paraffin Cake — ½"	45	C½-45K	L-S	1	.6	30A
Peanuts, Clean, in shell	15-20	D3-35Q	L-S	2	.6	30A
Peanut Meal	30	B6-35P	S	1	.6	30A
Peanuts, Raw, Uncleaned (unshelled)	15-20	D3-36Q	H	3	.7	30B
Peanuts, Shelled	35-45	C½-35Q	S	1	.4	30A
Peas, Dried	45-50	C½-15NQ	L-S-B	1	.5	45
Perlite — Expanded	8-12	C½-36	H	2	.6	30B
Phosphate Acid Fertilizer	60	B6-25T	L-S	2	1.4	45
Phosphate Disodium (See Sodium Phosphate)	—	—	—	—	—	—
Phosphate Rock, Broken	75-85	DX-36	H	2	2.1	30B
Phosphate Rock, Pulverized	60	B6-36	H	2	1.7	30B

Table 1-2 Material Characteristics (Cont'd)

Material	Weight lbs. per cu. ft.	Intermediate Material Code	Bearing Selection	Component Series	Mat'l Factor Fm	Trough Loading
Phosphate Sand	90-100	B6-37	H	3	2.0	15
Plaster of Paris (See Gypsum)	—	—	—	—	—	—
Plumbago (See Graphite)	—	—	—	—	—	—
Polystyrene Beads	40	B6-35PQ	S	1	.4	30A
Polyvinyl, Chloride Powder	20-30	A100-45KT	S	2	1.0	30A
Polyvinyl, Chloride Pellets	20-30	E-45KPQT	S	1	.6	30A
Polyethylene, Resin Pellets	30-35	C½-45Q	L-S	1	.4	30A
Potash (Muriate) Dry	70	B6-37	H	3	2.0	15
Potash (Muriate) Mine Run	75	DX-37	H	3	2.2	15
Potassium Carbonate	51	B6-36	H	2	1.0	30B
Potassium Chloride Pellets	120-130	C½-25TU	H	3	1.6	45
Potassium Nitrate — ½"	76	C½-16NT	H	3	1.2	30B
Potassium Nitrate — ⅜"	80	B6-26NT	H	3	1.2	30B
Potassium Sulfate	42-48	B6-46X	H	2	1.0	30B
Potato Flour	48	A200-35MNP	L-S	1	.5	30A
Pumice — ⅛"	42-48	B6-46	H	3	1.6	30B
Pyrite, Pellets	120-130	C½-26	H	3	2.0	30B
Quartz — 100 Mesh	70-80	A100-27	H	3	1.7	15
Quartz — ½"	80-90	C½-27	H	3	2.0	15
Rice, Bran	20	B6-35NY	L-S-B	1	.4	30A
Rice, Grits	42-45	B6-35P	L-S-B	1	.4	30A
Rice, Polished	30	C½-15P	L-S-B	1	.4	45
Rice, Hulled	45-49	C½-25P	L-S-B	1	.4	45
Rice, Hulls	20-21	B6-35NY	L-S-B	1	.4	30A
Rice, Rough	32-36	C½-35N	L-S-B	1	.6	30A
Rosin — ½"	65-68	C½-45Q	L-S-B	1	1.5	30A
Rubber, Reclaimed Ground	23-50	C½-45	L-S-B	1	.8	30A
Rubber, Pelleted	50-55	D3-45	L-S-B	2	1.5	30A
Rye	42-48	B6-15N	L-S-B	1	.4	45
Rye Bran	15-20	B6-35Y	L-S-B	1	.4	45
Rye Feed	33	B6-35N	L-S-B	1	.5	30A
Rye Meal	35-40	B6-35	L-S-B	1	.5	30A
Rye Middlings	42	B6-35	L-S	1	.5	30A
Rye, Shorts	32-33	C½-35	L-S	2	.5	30A
Safflower, Cake	50	D3-26	H	2	.6	30B
Safflower, Meal	50	B6-35	L-S-B	1	.6	30A
Safflower Seed	45	B6-15N	L-S-B	1	.4	45
Saffron (See Safflower)	—	—	—	—	—	—
Sal Ammoniac (Ammonium Chloride)	—	—	—	—	—	—
Salt Cake, Dry Coarse	85	B6-36TU	H	3	2.1	30B
Salt Cake, Dry Pulverized	65-85	B6-36TU	H	3	1.7	30B
Salicylic Acid	29	B6-37U	H	3	.6	15
Salt, Dry Coarse	45-60	C½-36TU	H	3	1.0	30B
Salt, Dry Fine	70-80	B6-36TU	H	3	1.7	30B
Saltpeter — (See Potassium Nitrate)	—	—	—	—	—	—
Sand Dry Bank (Damp)	110-130	B6-47	H	3	2.8	15
Sand Dry Bank (Dry)	90-110	B6-37	H	3	1.7	15
Sand Dry Silica	90-100	B6-27	H	3	2.0	15
Sand Foundry (Shake Out)	90-100	D3-37Z	H	3	2.6	15
Sand (Resin Coated) Silica	104	B6-27	H	3	2.0	15
Sand (Resin Coated) Zircon	115	A100-27	H	3	2.3	15
Sawdust, Dry	10-13	B6-45UX	L-S-B	1	1.4	15
Sea — Coal	65	B6-36	H	2	1.0	30B
Sesame Seed	27-41	B6-26	H	2	.6	30B
Shale, Crushed	85-90	C½-36	H	2	2.0	30B
Shellac, Powdered or Granulated	31	B6-35P	S	1	.6	30A

Material	Weight lbs. per cu. ft.	Material Code	Intermediate Bearing Selection	Component Series	Mat'l Factor F _m	Trough Loading
Silicon Dioxide (See Quartz)	—	—	—	—	—	—
Silica, Flour	80	A40-46	H	2	1.5	30B
Silica Gel + ½" - 3"	45	D3-37HKQU	H	3	2.0	15
Slag, Blast Furnace Crushed	130-180	D3-37Y	H	3	2.4	15
Slag, Furnace Granular, Dry	60-65	C½-37	H	3	2.2	15
Slate, Crushed, — ½"	80-90	C½-36	H	2	2.0	30B
Slate, Ground, — ¼"	82-85	B6-36	H	2	1.6	30B
Sludge, Sewage, Dried	40-50	E-47TW	H	3	.8	15
Sludge, Sewage, Dry Ground	45-55	B-46S	H	2	.8	30B
Soap, Beads or Granules	15-35	B6-35Q	L-S-B	1	.6	30A
Soap, Chips	15-25	C½-35Q	L-S-B	1	.6	30A
Soap Detergent	15-50	B6-35FQ	L-S-B	1	.8	30A
Soap, Flakes	5-15	B6-35QXY	L-S-B	1	.6	30A
Soap, Powder	20-25	B6-25X	L-S-B	1	.9	45
Soapstone, Talc, Fine	40-50	A200-45XY	L-S-B	1	2.0	30A
Soda Ash, Heavy	55-65	B6-36	H	2	2.0	30B
Soda Ash, Light	20-35	A40-36Y	H	2	1.6	30B
Sodium Aluminate, Ground	72	B6-36	H	2	1.0	30B
Sodium Aluminum Fluoride (See Kryolite)	—	—	—	—	—	—
Sodium Aluminum Sulphate*	75	A100-36	H	2	1.0	30B
Sodium Bentonite (See Bentonite)	—	—	—	—	—	—
Sodium Bicarbonate (See Baking Soda)	—	—	—	—	—	—
Sodium Chloride (See Salt)	—	—	—	—	—	—
Sodium Carbonate (See Soda Ash)	—	—	—	—	—	—
Sodium Hydrate (See Caustic Soda)	—	—	—	—	—	—
Sodium Hydroxide (See Caustic Soda)	—	—	—	—	—	—
Sodium Borate (See Borax)	—	—	—	—	—	—
Sodium Nitrate	70-80	D3-25NS	L-S	2	1.2	30A
Sodium Phosphate	50-60	A-35	L-S	1	.9	30A
Sodium Sulfate (See Salt Cake)	—	—	—	—	—	—
Sodium Sulfite	96	B6-46X	H	2	1.5	30B
Sorghum, Seed (See Kafir or Milo)	—	—	—	—	—	—
Soybean, Cake	40-43	D3-35W	L-S-B	2	1.0	30A
Soybean, Cracked	30-40	C½-36NW	H	2	.5	30B
Soybean, Flake, Raw	18-25	C½-35Y	L-S-B	1	.8	30A
Soybean, Flour	27-30	A40-35MN	L-S-B	1	.8	30A
Soybean Meal, Cold	40	B6-35	L-S-B	1	.5	30A
Soybean Meal Hot	40	B6-35T	L-S	2	.5	30A
Soybeans, Whole	45-50	C½-26NW	H	2	1.0	30B
Starch	25-50	A40-15M	L-S-B	1	1.0	45
Steel Turnings, Crushed	100-150	D3-46WV	H	3	3.0	30B
Sugar Beet, Pulp, Dry	12-15	C½-26	H	2	.9	30B
Sugar Beet, Pulp, Wet	25-45	C½-35X	L-S-B	1	1.2	30A
Sugar, Refined, Granulated Dry	50-55	B6-35PU	S	1	1.0-1.2	30A
Sugar, Refined, Granulated Wet	55-65	C½-35X	S	1	1.4-2.0	30A
Sugar, Powdered	50-60	A100-35PX	S	1	.8	30A
Sugar, Raw	55-65	B6-35PX	S	1	1.5	30A
Sulphur, Crushed — ½"	50-60	C½-35N	L-S	1	.8	30A
Sulphur, Lumpy, — 3"	80-85	D3-35N	L-S	2	.8	30A
Sulphur, Powdered	50-60	A40-35MN	L-S	1	.6	30A
Sunflower Seed	19-38	C½-15	L-S-B	1	.5	45
Talcum, — ½"	80-90	C½-36	H	2	.9	30B
Talcum Powder	50-60	A200-36M	H	2	.8	30B
Tanbark, Ground*	55	B6-45	L-S-B	1	.7	30A
Timothy Seed	36	B6-35NY	L-S-B	1	.6	30A
Titanium Dioxide (See Ilmenite Ore)	—	—	—	—	—	—

Table 1-2 Material Characteristics (Cont'd)



Material	Weight lbs. per cu. ft.	Material Code	Intermediate Bearing Selection	Component Series	Mat'l Factor F _m	Trough Loading
Tobacco, Scraps	15-25	D3-45Y	L-S	2	.8	30A
Tobacco, Snuff	30	B6-45MQ	L-S-B	1	.9	30A
Tricalcium Phosphate	40-50	A40-45	L-S	1	1.6	30A
Triple Super Phosphate	50-55	B6-36RS	H	3	2.0	30B
Trisodium Phosphate	60	C½-36	H	2	1.7	30B
Trisodium Phosphate Granular	60	B6-36	H	2	1.7	30B
Trisodium Phosphate, Pulverized	50	A40-36	H	2	1.6	30B
Tung Nut Meats, Crushed	28	D3-25W	L-S	2	.8	30A
Tung Nuts	25-30	D3-15	L-S	2	.7	30A
Urea Prills, Coated	43-46	B6-25	L-S-B	1	1.2	45
Vermiculite, Expanded	16	C½-35Y	L-S	1	.5	30A
Vermiculite, Ore	80	D3-36	H	2	1.0	30B
Vetch	48	B6-16N	L-S-B	1	.4	30B
Walnut Shells, Crushed	35-45	B6-36	H	2	1.0	30B
Wheat	45-48	C½-25N	L-S-B	1	.4	45
Wheat, Cracked	40-45	B6-25N	L-S-B	1	.4	45
Wheat, Germ	18-28	B6-25	L-S-B	1	.4	45
White Lead, Dry	75-100	A40-36MR	H	2	1.0	30B
Wood Chips, Screened	10-30	D3-45VY	L-S	2	.6	30A
Wood Flour	16-36	B6-35N	L-S	1	.4	30A
Wood Shavings	8-16	E-45VY	L-S	2	1.5	30A
Zinc, Concentrate Residue	75-80	B6-37	H	3	1.0	15
Zinc Oxide, Heavy	30-35	A100-45X	L-S	1	1.0	30A
Zinc Oxide, Light	10-15	A100-45XY	L-S	1	1.0	30A

*Consult Factory

In order to determine the size and speed of a screw conveyor, it is necessary first to establish the material code number. It will be seen from what follows that this code number controls the cross-sectional loading that should be used. The various cross-sectional loadings shown in the Capacity Table (Table 1-6) are for use with the standard screw conveyor components indicated in the Component Group Selection Guide on page H-22 and are for use where the conveying operation is controlled with volumetric feeders and where the material is uniformly fed into the conveyor housing and discharged from it. Check lump size limitations before choosing conveyor diameter. See Table 1-7.

Capacity Table

The capacity table, (Table 1-6), gives the capacities in cubic feet per hour at one revolution per minute for various size screw conveyors for four cross-sectional loadings. Also shown are capacities in cubic feet per hour at the maximum recommended revolutions per minute.

The capacity values given in the table will be found satisfactory for most applications. Where the capacity of a screw conveyor is very critical, especially when handling a material not listed in Table 1-2, it is best to consult our Engineering Department.

The maximum capacity of any size screw conveyor for a wide range of materials, and various conditions of loading, may be obtained from Table 1-6 by noting the values of cubic feet per hour at maximum recommended speed.

Conveyor Speed

For screw conveyors with screws having standard pitch helical flights the conveyor speed may be calculated by the formula:

$$N = \frac{\text{Required capacity, cubic feet per hour}}{\text{Cubic feet per hour at 1 revolution per minute}}$$

$$N = \text{revolutions per minute of screw, (but not greater than the maximum recommended speed.)}$$

For the calculation of conveyor speeds where special types of screws are used, such as short pitch screws, cut flights, cut and folded flights and ribbon flights, an equivalent required capacity must be used, based on factors in the Tables 1-3, 4, 5.

Factor CF_1 relates to the pitch of the screw. Factor CF_2 relates to the type of the flight. Factor CF_3 relates to the use of mixing paddles within the flight pitches.

The equivalent capacity then is found by multiplying the required capacity by the capacity factors. See Tables 1-3, 4, 5 for capacity factors.

$$\left(\begin{array}{c} \text{Equiv. Capacity} \\ \text{Cubic Feet Per Hour} \end{array} \right) = \left(\begin{array}{c} \text{Required Capacity} \\ \text{Cubic Feet Per Hour} \end{array} \right) (CF_1) (CF_2) (CF_3)$$

Capacity Factors



Table 1-3

Special Conveyor Pitch Capacity Factor CF_1		
Pitch	Description	CF_1
Standard	Pitch = Diameter of Screw	1.00
Short	Pitch = $\frac{2}{3}$ Diameter of Screw	1.50
Half	Pitch = $\frac{1}{2}$ Diameter of Screw	2.00
Long	Pitch = $1\frac{1}{2}$ Diameter of Screw	0.67

Table 1-4

Special Conveyor Flight Capacity Factor CF_2			
Type of Flight	Conveyor Loading		
	15%	30%	45%
Cut Flight	1.95	1.57	1.43
Cut & Folded Flight	N.R.*	3.75	2.54
Ribbon Flight	1.04	1.37	1.62

*Not recommended
 If none of the above flight modifications are used: $CF_2 = 1.0$

Table 1-5

Special Conveyor Mixing Paddle Capacity CF_3					
Standard Paddles at 45° Reverse Pitch	Paddles Per Pitch				
	None	1	2	3	4
Factor CF_3	1.00	1.08	1.16	1.24	1.32

(Consult Factory for Inclined Conveyors)

Table 1-6

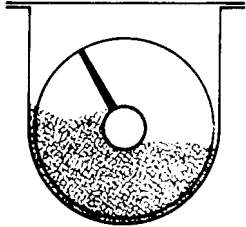
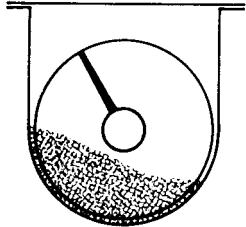
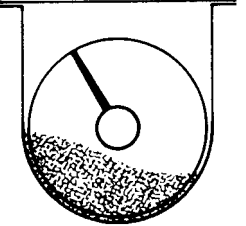
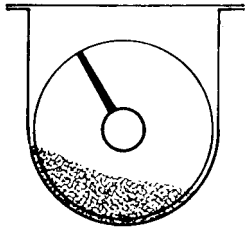
	Trough Loading	Screw Dia. Inch	Capacity Cubic Feet Per Hour (Full Pitch)		Max. RPM
			At One RPM	At Max RPM	
45%		4	0.62	114	184
		6	2.23	368	165
		9	8.20	1270	155
		10	11.40	1710	150
		12	19.40	2820	145
		14	31.20	4370	140
		16	46.70	6060	130
		18	67.60	8120	120
		20	93.70	10300	110
		24	164.00	16400	100
		30	323.00	29070	90
30% A		4	0.41	53	130
		6	1.49	180	120
		9	5.45	545	100
		10	7.57	720	95
		12	12.90	1160	90
		14	20.80	1770	85
		16	31.20	2500	80
		18	45.00	3380	75
		20	62.80	4370	70
		24	109.00	7100	65
		30	216.00	12960	60
30% B		4	0.41	29	72
		6	1.49	90	60
		9	5.45	300	55
		10	7.60	418	55
		12	12.90	645	50
		14	20.80	1040	50
		16	31.20	1400	45
		18	45.00	2025	45
		20	62.80	2500	40
		24	109.00	4360	40
		30	216.00	7560	35
15%		4	0.21	15	72
		6	0.75	45	60
		9	2.72	150	55
		10	3.80	210	55
		12	6.40	325	50
		14	10.40	520	50
		16	15.60	700	45
		18	22.50	1010	45
		20	31.20	1250	40
		24	54.60	2180	40
		30	108.00	3780	35

Lump Size Limitations



The size of a screw conveyor not only depends on the capacity required, but also on the size and proportion of lumps in the material to be handled. The size of a lump is the maximum dimension it has. If a lump has one dimension much longer than its transverse cross-section, the long dimension or length would determine the lump size.

The character of the lump also is involved. Some materials have hard lumps that won't break up in transit through a screw conveyor. In that case, provision must be made to handle these lumps. Other materials may have lumps that are fairly hard, but degradable in transit through the screw conveyor, thus reducing the lump size to be handled. Still other materials have lumps that are easily broken in a screw conveyor and lumps of these materials impose no limitations.

Three classes of lump sizes are shown in TABLE 1-7 and as follows

Class 1

A mixture of lumps and fines in which not more than 10% are lumps ranging from maximum size to one half of the maximum; and 90% are lumps smaller than one half of the maximum size.

Class 2

A mixture of lumps and fines in which not more than 25% are lumps ranging from the maximum size to one half of the maximum; and 75% are lumps smaller than one half of the maximum size.

Class 3

A mixture of lumps only in which 95% or more are lumps ranging from maximum size to one half of the maximum size; and 5% or less are lumps less than one tenth of the maximum size.

Table 1-7

Maximum Lump Size Table					
Screw Diameter Inches	Pipe *O.D. Inches	Radial Clearance Inches Δ	Class I 10% Lumps Max. Lump, Inch	Class II 25% Lumps Max. Lump, Inch	Class III 95% Lumps Max. Lump, Inch
6	2 ⁵ / ₈	2 ⁵ / ₈	1 ¹ / ₄	¾	½
9	2 ⁵ / ₈	3 ³ / ₈	2 ¹ / ₄	1½	¾
9	2 ⁷ / ₈	3 ³ / ₈	2 ¹ / ₄	1½	¾
12	2 ⁷ / ₈	5 ¹ / ₈	2 ³ / ₄	2	1
12	3½	4¾	2¾	2	1
12	4	4½	2¾	2	1
14	3½	5¾	3¾	2½	1¼
14	4	5½	2½	1¼	1¼
16	4	6½	3¾	2¾	1½
16	4½	6¾	3¾	2¾	1½
18	4	7½	4¾	3	1¾
18	4½	7½	4¾	3	1¾
20	4	8½	4¾	3½	2
20	4½	8¾	4¾	3½	2
24	4½	10¾	6	3¾	2½
30	4½	13¾	8	5	3

*For special pipe sizes, consult factory.

ΔRadial clearance is the distance between the bottom of the trough and the bottom of the conveyor pipe.

EXAMPLE: Lump Size Limitations

To illustrate the selection of a conveyor size from the Maximum Lump Size Table, Table 1-7, consider crushed ice as the conveyed material. Refer to the material charts Table 1-2 and find crushed ice and its material code D3-35Q and weight of 35-45 lbs./C.F. D3 means that the lump size is ½" to 3", this is noted by referring to the material classification code chart on page H-6. From actual specifications regarding crushed ice it is known that crushed ice has a maximum lump size of 1½" and only 25% of the lumps are 1½". With this information refer to Table 1-7, Maximum Lump Size Table. Under the column Class II and 1½" Max. lump size read across to the minimum screw diameter which will be 9".

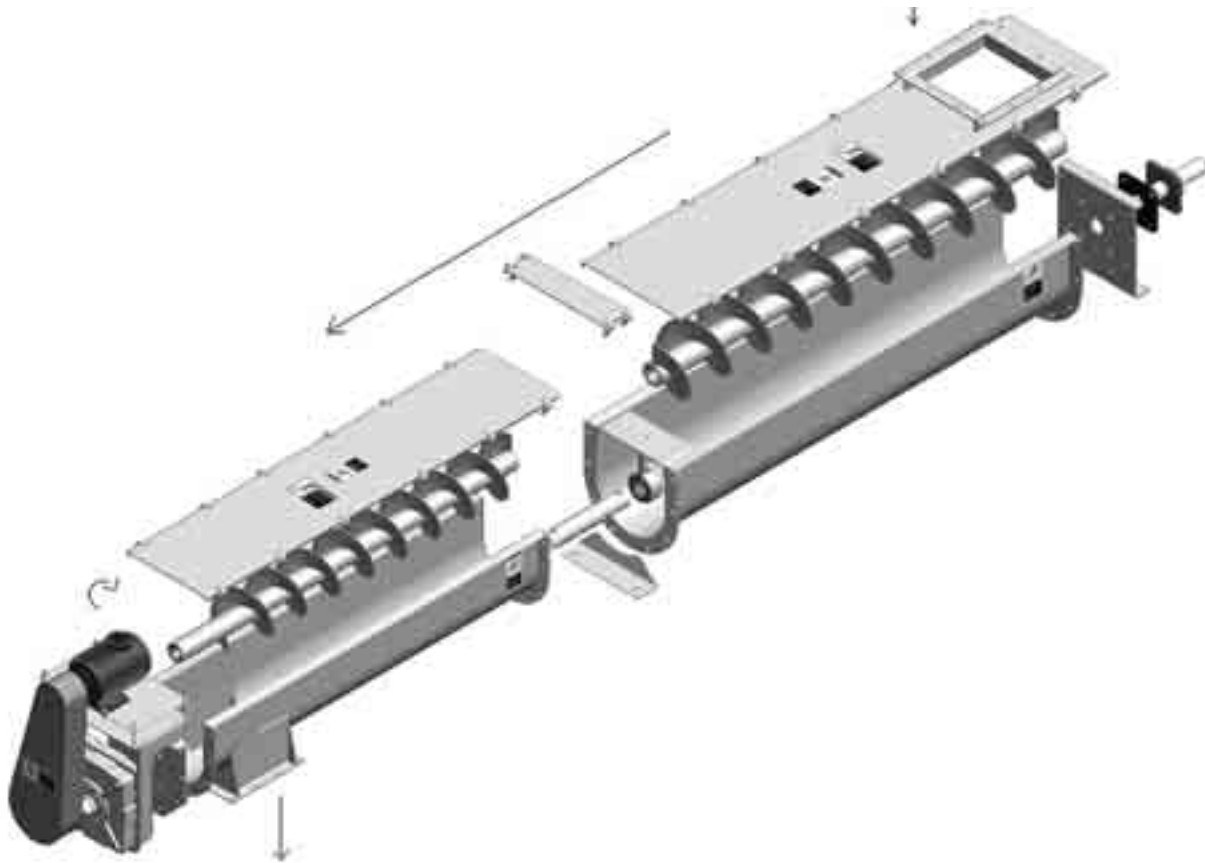

Component Groups

To facilitate the selection of proper specifications for a screw conveyor for a particular duty, screw conveyors are broken down into three Component Groups. These groups relate both to the Material Classification Code and also to screw size, pipe size, type of bearings and trough thickness.

Referring to Table 1-2, find the component series designation of the material to be conveyed.

Having made the Component Series selection, refer to Tables 1-8, 9, 10 which give the specifications of the various sizes of conveyor screws. (The tabulated screw numbers in this table refer to standard specifications for screws found on pages H-79 - H-83 Component Section.) These standards give complete data on the screws such as the length of standard sections, minimum edge thickness of screw flight, bushing data, bolt size, bolt spacing, etc.

EXAMPLE: For a screw conveyor to handle brewers grain, spent wet, refer to the material characteristics Table 1-2. Note that the component series column refers to series 2. Refer now to page H-22, component selection, Table 1-9, component group 2. The standard shaft sizes, screw flight designations, trough gauges and cover gauges are listed for each screw diameter.

Component Selection



Table 1-8

Component Group 1					
Screw Diameter Inches	Coupling Diameter Inches	Screw Number		Thickness, U.S. Standard Gauge or Inches	
		Helicoid Flights	Sectional Flights	Trough	Cover
6	1½	6H304	6S307	16 Ga.	16 Ga.
9	1½	9H306	9S307	14 Ga.	14 Ga.
9	2	9H406	9S409	14 Ga.	14 Ga.
12	2	12H408	12S409	12 Ga.	14 Ga.
12	2⅙	12H508	12S509	12 Ga.	14 Ga.
14	2⅙	14H508	14S509	12 Ga.	14 Ga.
16	3	16H610	16S612	12 Ga.	14 Ga.
18	3	—	18S612	10 Ga.	12 Ga.
20	3	—	20S612	10 Ga.	12 Ga.
24	3⅙	—	24S712	10 Ga.	12 Ga.
30	3⅙	—	30S712	10 Ga.	12 Ga.

Table 1-9

Component Group 2					
Screw Diameter Inches	Coupling Diameter Inches	Screw Number		Thickness, U.S. Standard Gauge or Inches	
		Helicoid Flights	Sectional Flights	Trough	Cover
6	1½	6H308	6S309	14 Ga..	16 Ga..
9	1½	9H312	9S309	10 Ga.	14 Ga.
9	2	9H412	9S412	10 Ga.	14 Ga.
12	2	12H412	12S412	⅝ In.	14 Ga.
12	2⅙	12H512	12S512	⅝ In.	14 Ga.
12	3	12H614	12S616	⅝ In.	14 Ga.
14	2⅙	—	14S512	⅝ In.	14 Ga.
14	3	14H614	14S616	⅝ In.	14 Ga.
16	3	16H614	16S616	⅝ In.	14 Ga.
18	3	—	18S616	⅝ In.	12 Ga.
20	3	—	20S616	⅝ In.	12 Ga.
24	3⅙	—	24S716	⅝ In.	12 Ga.
30	3⅙	—	30S716	⅝ In.	12 Ga.

Table 1-10

Component Group 3					
Screw Diameter Inches	Coupling Diameter Inches	Screw Number		Thickness, U.S. Standard Gauge or Inches	
		Helicoid Flights	Sectional Flights	Trough	Cover
6	1½	6H312	6S312	10 Ga.	16 Ga.
9	1½	9H312	9S312	⅝ In.	14 Ga.
9	2	9H414	9S416	⅝ In.	14 Ga.
12	2	12H412	12S412	¼ In.	14 Ga.
12	2⅙	12H512	12S512	¼ In.	14 Ga.
12	3	12H614	12S616	¼ In.	14 Ga.
14	3	—	14S624	¼ In.	14 Ga.
16	3	—	16S624	¼ In.	14 Ga.
18	3	—	18S624	¼ In.	12 Ga.
20	3	—	20S624	¼ In.	12 Ga.
24	3⅙	—	24S724	¼ In.	12 Ga.
30	3⅙	—	30S724	¼ In.	12 Ga.



Bearing Selection

The selection of bearing material for intermediate hangers is based on experience together with a knowledge of the characteristics of the material to be conveyed. By referring to the material characteristic tables, page H-8 thru H-16 the intermediate hanger bearing selection can be made by viewing the Bearing Selection column. The bearing selection will be made from one of the following types: B, L, S, H. The various bearing types available in the above categories can be selected from the following table.

Table 1-11

Hanger Bearing Selection				
Bearing Component Groups	Bearing Types	Recommended Coupling Shaft Material Δ	Max. Recommended Operating Temperature	F _b
B	Ball	Standard	180°	1.0
L	Bronze	Standard	300°F	
S	<i>Martin</i> Bronze*	Standard	850°F	2.0
	Graphite Bronze	Standard	500°F	
	Oil Impreg. Bronze	Standard	200°F	
	Oil Impreg. Wood	Standard	160°F	
	Nylatron	Standard	250°F	
	Nylon	Standard	160°F	
	Teflon	Standard	250°F	
	UHMW	Standard	225°F	
	Melamine (MCB)	Standard	250°F	
Urethane	Standard	200°F		
H	<i>Martin</i> Hard Iron*	Hardened	500°F	3.4
	Hard Iron	Hardened	500°F	4.4
	Hard Surfaced	Hardened or Special	500°F	
	Stellite	Special	500°F	
Ceramic	Special	1,000°F		

*Sintered Metal. Self-lubricating.

Δ OTHER TYPES OF COUPLING SHAFT MATERIALS

Various alloys, stainless steel, and other types of shafting can be furnished as required.

Horsepower Requirements



Horizontal Screw Conveyors

***Consult Factory for Inclined Conveyors or Screw Feeders**

The horsepower required to operate a horizontal screw conveyor is based on proper installation, uniform and regular feed rate to the conveyor and other design criteria as determined in this book.

The horsepower requirement is the total of the horsepower to overcome friction (HP_f) and the horsepower to transport the material at the specified rate (HP_m) multiplied by the overload factor F_o and divided by the total drive efficiency e , or:

$$HP_f = \frac{LN F_d f_b}{1,000,000} = \text{(Horsepower to run an empty conveyor)}$$

$$HP_m = \frac{CLW F_f F_m F_p}{1,000,000} = \text{(Horsepower to move the material)}$$

$$\text{Total HP} = \frac{(HP_f + HP_m) F_o}{e}$$

The following factors determine the horsepower requirement of a screw conveyor operating under the foregoing conditions.

- L = Total length of conveyor, feet
- N = Operating speed, RPM (revolutions per minute)
- F_d = Conveyor diameter factor (See Table 1-12)
- F_b = Hanger bearing factor (See Table 1-13)
- C = Capacity in cubic feet per hour
- W = Weight of material, lbs. per cubic foot
- F_f = Flight factor (See Table 1-14)
- F_m = Material factor (See Table 1-2)
- F_p = Paddle factor, when required. (See Table 1-15)
- F_o = Overload factor (See Table 1-16)
- e = Drive efficiency (See Table 1-17)

Table 1-12

Conveyor Diameter Factor, F_d			
Screw Diameter Inches	Factor F_d	Screw Diameter Inches	Factor F_d
4	12.0	14	78.0
6	18.0	16	106.0
9	31.0	18	135.0
10	37.0	20	165.0
12	55.0	24	235.0
		30	300

Table 1-13

Hanger Bearing Factor F_b		
Bearing Type		Hanger Bearing Factor F_b
B	Ball	1.0
L	<i>Martin</i> Bronze	2.0
S	*Graphite Bronze *Melamine *Oil Impreg. Bronze *Oil Impreg. Wood *Nylatron *Nylon *Teflon *UHMW *Urethane	2.0
	* <i>Martin</i> Hard Iron	3.4
H	*Hard Surfaced *Stellite *Ceramic	4.4

*Non lubricated bearings, or bearings not additionally lubricated.

Table 1-14
Flight Factor, F_f

Flight Type	F_f Factor for Percent Conveyor Loading			
	15%	30%	45%	95%
Standard	1.0	1.0	1.0	1.0
Cut Flight	1.10	1.15	1.20	1.3
Cut & Folded Flight	N.R.*	1.50	1.70	2.20
Ribbon Flight	1.05	1.14	1.20	—
*Not Recommended				

Table 1-15

Paddle Factor F_p					
Standard Paddles per Pitch, Paddles Set at 45° Reverse Pitch					
Number of Paddles per Pitch	0	1	2	3	4
Paddle Factor — F_p	1.0	1.29	1.58	1.87	2.16

Table 1-16

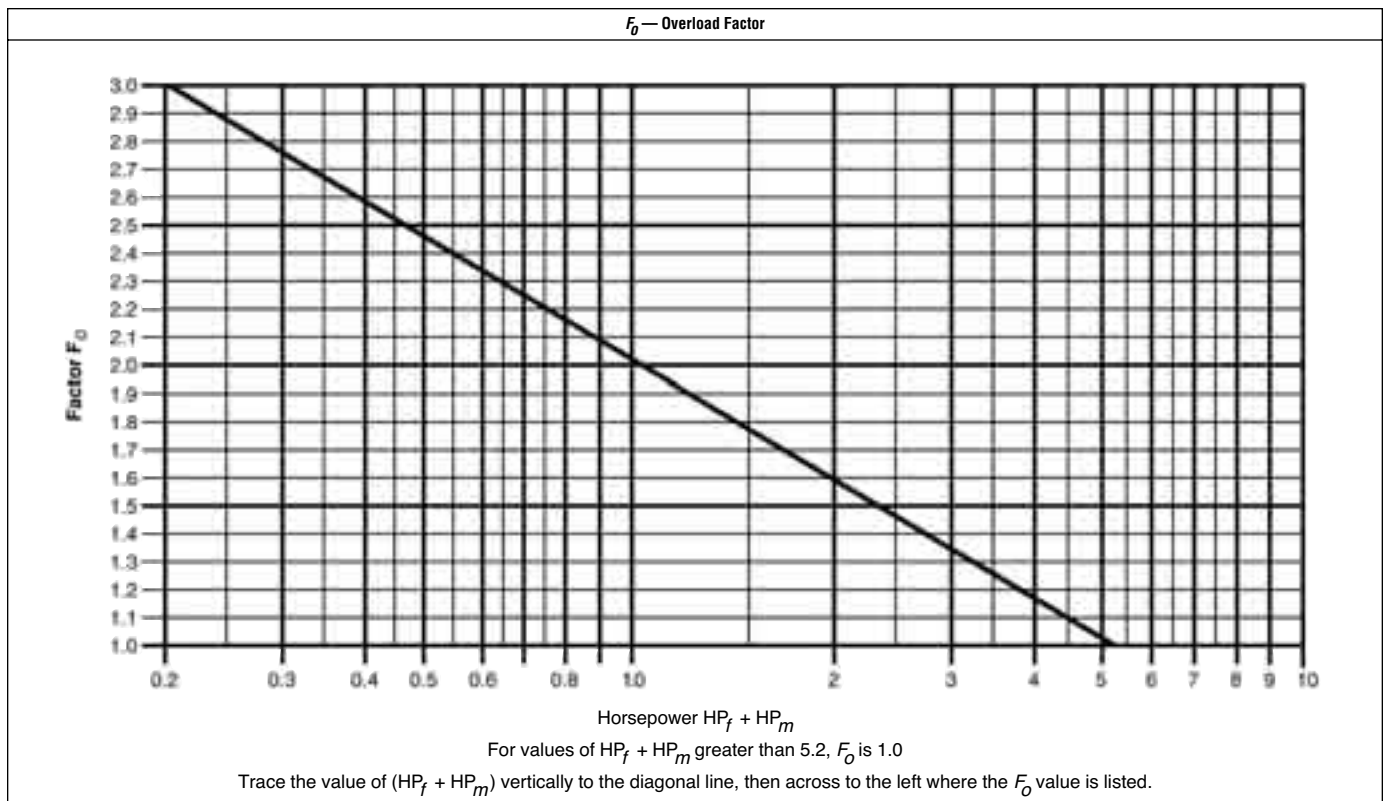

Table 1-17

e Drive Efficiency Factor				
Screw Drive or Shaft Mount w/ V-Belt Drive	V-Belt to Helical Gear and Coupling	Gearmotor w/ Coupling	Gearmotor w/ Chain Drive	Worm Gear
.88	.87	.95	.87	Consult Manufacturer

Horsepower

EXAMPLE: Horsepower Calculation (See page H-50 for sample worksheet)

PROBLEM: Convey 1,000 cubic feet per hour Brewers grain, spent wet, in a 25'-0" long conveyor driven by a screw conveyor drive with V-belts.

SOLUTION:

1. Refer to material characteristic table 1-2 for Brewers grain, spent wet and find:
 - A. wt/cf: 55 - 60
 - B. material code: C½ - 45T
Refer to Table 1-1, material classification code chart where:
C½ = Fine ½" and under
4 = Sluggish
5 = Mildly abrasive
T = Mildly corrosive
 - C. Intermediate bearing selection: L or S
Refer to Table 1-11 Bearing Selection, Find:
L = Bronze
S = Nylatron, Nylon, Teflon, UHMW Melamine, Graphite Bronze, Oil-impreg. Bronze, and oil-impreg. wood and Urethane.
 - D. Material Factor: $F_m = .8$
 - E. Trough Loading: 30%A
Refer to Table 1-6 capacity table and find 30%A which shows the various capacities per RPM of the standard size screw conveyors and the maximum RPM's for those sizes.
2. From Table 1-6, Capacity table under 30%A note that a 12" screw will convey 1,160 cubic feet per hour at 90 RPM maximum, therefore at 1 RPM a 12" screw will convey 12.9 cubic feet. For 1,000 CFH capacity at 12.9 CFH per RPM, the conveyor must therefore run 78RPM ($1000 \div 12.9 = 77.52$).
3. With the above information and factors from Tables 1-12 through 1-17 refer to the horsepower formulas on H-24 and calculate the required horsepower to convey 1000 CF/H for 25 feet in a 12" conveyor.

Using the known factors find that:

L = 25'	C = 1000 CFH
N = 78 RPM from step 2 above	W = 60#/CF from step 1A
$F_d = 55$ see Table 1-12, for 12"	$F_f = 1$ see Table 1-14, standard 30%
$F_b = 2.0$ see Table 1-13 for L	$F_p = 1$ see Table 1-15
	e = .88 see Table 1-17

4. Solve the following horsepower equations:

$$A. HP_f = \frac{L N F_d F_b}{1,000,000} = \frac{25 \times 78 \times 55 \times 2.0}{1,000,000} = 0.215$$

$$B. HP_m = \frac{C L W F_f F_m F_p}{1,000,000} = \frac{1000 \times 25 \times 60 \times 1 \times .8 \times 1}{1,000,000} = 1.2$$

Find the F_o factor from 1-16; by adding HP_f and HP_m and matching this sum to the values on the chart.

$$C. HP_f = \frac{(HP_f + HP_m) (F_o)}{e} = \frac{(1.414) (1.9)}{.88} = 3.05$$

SOLUTION: 3.05 Horsepower is required to convey 1,000 CFH Brewers grain, spent wet in a 12" conveyor for 25 feet. A 5 H.P. motor should be used.



Torsional Ratings of Conveyor Screw Parts

Screw conveyors are limited in overall design by the amount of torque that can be safely transmitted through the pipes, couplings, and coupling bolts.

The table below combines the various torsional ratings of bolts, couplings and pipes so that it is easy to compare the torsional ratings of all the stressed parts of standard conveyor screws.

Table 1-18

Coupling Shaft Dia. In.	Pipe		Couplings		Bolt Dia. In.	Bolts			
	Sch. 40		Torque in Lbs.*			Bolts in Shear in Lbs. ▲		Bolts in Bearing in Lbs.	
	Size In.	Torque In. Lbs.	CEMA Std. (C-1018)	Martin (C-1045) Std.		No. of Bolts Used		No. of Bolts Used	
						2	3	2	3
1	1½	3,140	820	999	¾	1,380	2,070	1,970	2,955
1½	2	7,500	3,070	3,727	½	3,660	5,490	5,000	7,500
2	2½	14,250	7,600	9,233	¾	7,600	11,400	7,860	11,790
2⅞	3	23,100	15,090	18,247	¾	9,270	13,900	11,640	17,460
3	3½	32,100	28,370	34,427	¾	16,400	24,600	15,540	23,310
3	4	43,000	28,370	34,427	¾	16,400	24,600	25,000	37,500
3⅞	4	43,300	42,550	51,568	¾	25,600	38,400	21,800	32,700

▲ Values shown are for A307-64, Grade 2 Bolts. Values for Grade 5 Bolts are above × 2.5
 *Values are for unheattreated shafts.

The lowest torsional rating figure for any given component will be the one that governs how much torque may be safely transmitted. For example, using standard unhardened two bolt coupling shafts, the limiting torsional strength of each part is indicated by the underlined figures in Table 1-18.

Thus it can be seen that the shaft itself is the limiting factor on 1", 1½" and 2" couplings. The bolts in shear are the limiting factors on the 2⅞" coupling and on the 3" coupling used in conjunction with 4" pipe. The bolts in bearing are the limiting factors for the 3" coupling used in conjunction with 3½" pipe, and for the 3⅞" coupling.

Formula: Horsepower To Torque (In. Lbs.)

$$\frac{63,025 \times \text{HP}}{\text{RPM}} = \text{Torque (In. Lbs.)}$$

EXAMPLE: 12" Screw, 78 RPM, 5 Horsepower

$$\frac{63,025 \times 5}{78} = 4,040 \text{ In. Lbs.}$$

From the table above 2" shafts with 2 bolt drilling and 2½" std. pipe are adequate (4,040 < 7600).

If the torque is greater than the values in the above table, such as in 2" couplings (torque > 7600), then hardened shafts can be used as long as the torque is less than the value for hardened couplings (torque < 9500). If the torque is greater than the 2 bolt in shear value but less than the 3 bolt in shear value then 3 bolt coupling can be used. The same applies with bolts in bearing. When the transmitted torque is greater than the pipe size value, then larger pipe or heavier wall pipe may be used. Other solutions include: high torque bolts to increase bolt in shear rating, external collars, or bolt pads welded to pipe to increase bolt in bearing transmission. For solutions other than those outlined in the above table please consult our Engineering Department.

Horsepower Ratings of Conveyor Screw Parts



Screw conveyors are limited in overall design by the amount of horsepower that can be safely transmitted through the pipes, couplings, and coupling bolts.

The table below combines the various horsepower ratings of bolts, couplings and pipes so that it is easy to compare the ratings of all the stressed parts of standard conveyor screws.

Table 1-19

Coupling		Pipe		Couplings		Bolts			
Shaft Dia. In.	Size In.	H.P. per R.P.M.	H.P. per R.P.M.		Bolt Dia. In.	Bolts in Shear H.P. per R.P.M. ▲		Bolts in Bearing H.P. per R.P.M.	
			CEMA Std. (C-1018)	Martin (C-1045) Std.		No. of Bolts Used		No. of Bolts Used	
						2	3	2	3
1	1¼	.049	.013	.016	⅜	.021	.032	.031	.046
1½	2	.119	.048	.058	½	.058	.087	.079	.119
2	2½	.226	.120	.146	⅝	.120	.180	.124	.187
2⅞	3	.366	.239	.289	⅝	.147	.220	.184	.277
3	3½	.509	.450	.546	¾	.260	.390	.246	.369
3	4	.682	.450	.546	¾	.260	.390	.396	.595
3⅞	4	.682	.675	.818	7⁄8	.406	.609	.345	.518

▲ Values shown are for A307-64, Grade 2 Bolts.

The lowest horsepower rating figure for any given component will be the one that governs how much horsepower may be safely transmitted. The limiting strength of each part is indicated by the underlined figures in the table above.

Formula: Horsepower To Horsepower @ 1 RPM

EXAMPLE: 12" Screw, 78 RPM, 5 Horsepower

$$\frac{5 \text{ HP}}{78 \text{ RPM}} = 0.06 \text{ HP at 1 RPM}$$

From the table above .038 is less than the lowest limiting factor for 2" couplings, so 2" standard couplings with 2 bolts may be used. Solutions to limitations are the same as shown on H-27.

End thrust in a Screw Conveyor is created as a reaction to the forces required to move the material along the axis of the conveyor or trough. Such a force is opposite in direction to the flow of material. A thrust bearing and sometimes reinforcement of the conveyor or trough is required to resist thrust forces. Best performance can be expected if the conveyor end thrust bearing is placed so that the rotating members are in tension; therefore, an end thrust bearing should be placed at the discharge end of a conveyor. Placing an end thrust bearing assembly at the feed end of a conveyor places rotating members in compression which may have undesirable effects, but this is sometimes necessary in locating equipment.

There are several methods of absorbing thrust forces, the most popular methods are:

1. Thrust washer assembly — installed on the shaft between the pipe end and the trough end plate, or on the outside of the end bearing.
2. Type “E” end thrust assembly, which is a Double Roller Bearing and shaft assembly.
3. Screw Conveyor Drive Unit, equipped with double roller bearing thrust bearings, to carry both thrust and radial loads.

Past experience has established that component selection to withstand end thrust is rarely a critical factor and thrust is not normally calculated for design purposes. Standard conveyor thrust components will absorb thrust without resorting to special design in most applications.

Expansion of Screw Conveyors Handling Hot Materials

Screw conveyors often are employed to convey hot materials. It is therefore necessary to recognize that the conveyor will increase in length as the temperature of the trough and screw increases when the hot material begins to be conveyed.

The recommended general practice is to provide supports for the trough which will allow movement of the trough end feet during the trough expansion, and during the subsequent contraction when handling of the hot material ceases. The drive end of the conveyor usually is fixed, allowing the remainder of the trough to expand or contract. In the event there are intermediate inlets or discharge spouts that cannot move, the expansion type troughs are required.

Furthermore, the conveyor screw may expand or contract in length at different rates than the trough. Therefore, expansion hangers are generally recommended. The trough end opposite the drive should incorporate an expansion type ball or roller bearing or sleeve bearing which will safely provide sufficient movement.

The change in screw conveyor length may be determined from the following formula:

$$\Delta L = L (t_1 - t_2) C$$

Where: ΔL = increment of change in length, inch

L = overall conveyor length in inches

t_1 = upper limit of temperature, degrees Fahrenheit

t_2 = limit of temperature, degrees Fahrenheit,
(or lowest ambient temperature expected)

C = coefficient of linear expansion, inches per inch per degree Fahrenheit. This coefficient has the following values for various metals:

(a) Hot rolled carbon steel, 6.5×10^{-6} , (.0000065)

(b) Stainless steel, 9.9×10^{-6} , (.0000099)

(c) Aluminum, 12.8×10^{-6} , (.0000128)

EXAMPLE:

A carbon steel screw conveyor 30 feet overall length is subject to a rise in temperature of 200°F, reaching a hot metal temperature of 260°F from an original metal temperature of 60°F.

$$t_1 = 260 \quad t_1 - t_2 = 200$$

$$t_2 = 60$$

$$L = (30) (12) = 360$$

$$\Delta L = (360) (200) (6.5 \times 10^{-6})$$

$$= 0.468 \text{ inches, or about } \frac{15}{32} \text{ inches.}$$

Conveyor Screw Deflection



When using conveyor screws of standard length, deflection is seldom a problem. However, if longer than standard sections of screw are to be used, without intermediate hanger bearings, care should be taken to prevent the screw flights from contacting the trough because of excessive deflection. The deflection at mid span may be calculated from the following formula.

$$D = \frac{5WL^3}{384 (29,000,000) (I)}$$

Where: D = Deflection at mid span in inches

W = Total screw weight in pounds, see pages H-81 to H-83

L = Screw length in inches

I = Movement of inertia of pipe or shaft, see table 1-20 or 1-21 below

Table 1-20 Schedule 40 Pipe

Pipe Size	2"	2½"	3"	3½"	4"	5"	6"	8"	10"
I	.666	1.53	3.02	4.79	7.23	15.2	28.1	72.5	161

Table 1-21 Schedule 80 Pipe

Pipe Size	2"	2½"	3"	3½"	4"	5"	6"	8"	10"
I	.868	1.92	3.89	6.28	9.61	20.7	40.5	106	212

EXAMPLE: Determine the deflection of a 12H512 screw conveyor section mounted on 3" sch 40 pipe, overall length is 16'-0".

W = 272#

L = 192"

I = 3.02 (From chart above)

$$D = \frac{5 (272\#) (192^3)}{384 (29,000,000) (3.02)} = .29 \text{ inches}$$

Applications where the calculated deflection of the screw exceeds .25 inches (¼") should be referred to our Engineering Department for recommendations. Very often the problem of deflection can be solved by using a conveyor screw section with a larger diameter pipe or a heavier wall pipe. Usually, larger pipe sizes tend to reduce deflection more effectively than heavier wall pipe.

CONVEYORS

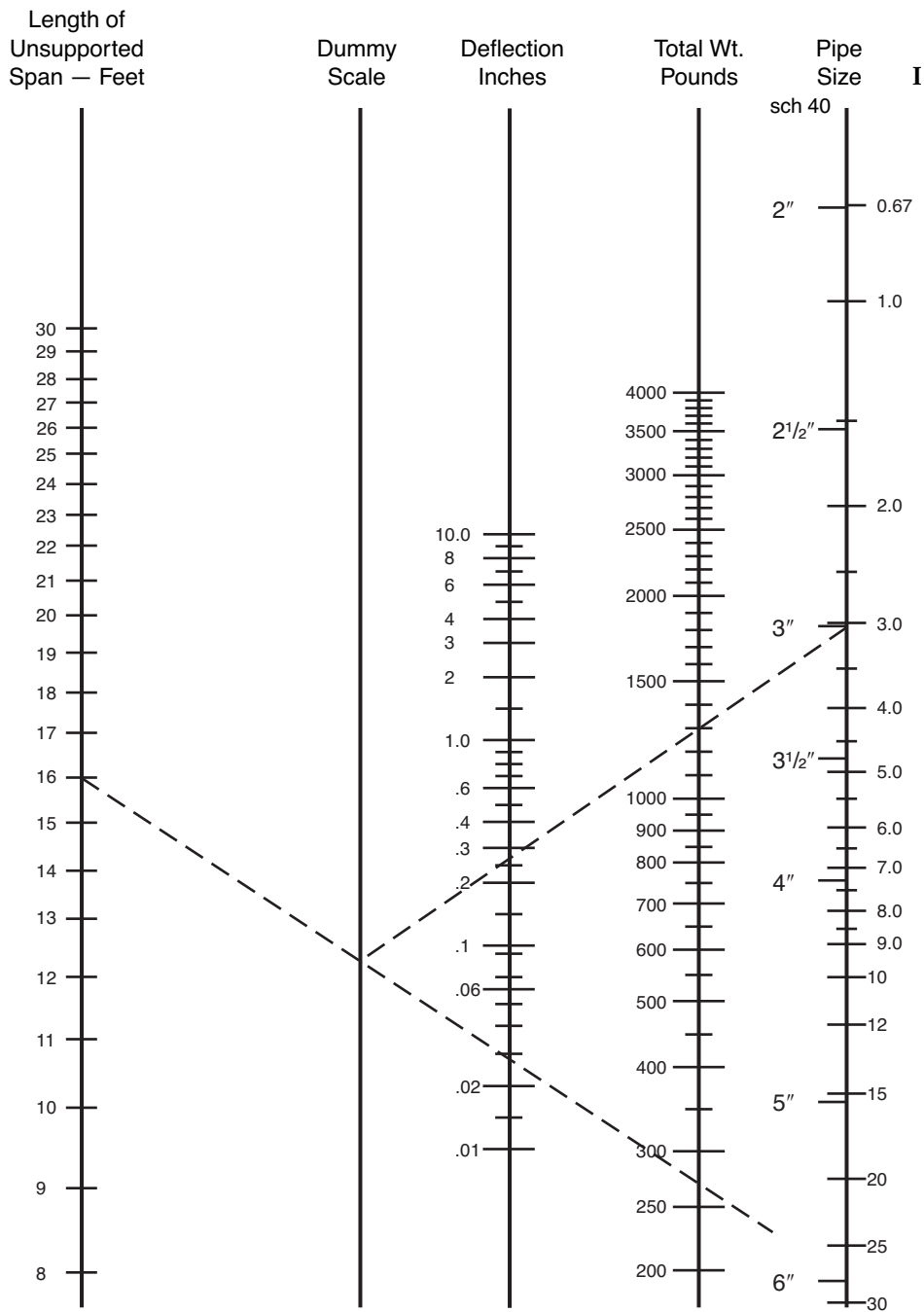

I = Moment of inertia of pipe or shaft, see Table 1-20 or 1-21

The above Nomograph can be used for a quick reference to check deflection of most conveyors.

Inclined and Vertical Screw Conveyors



Inclined
Screw
Conveyors

Inclined screw conveyors have a greater horsepower requirement and a lower capacity rating than horizontal conveyors. The amounts of horsepower increase and capacity loss depend upon the angle of incline and the characteristics of the material conveyed.

Inclined conveyors operate most efficiently when they are of tubular or shrouded cover design, and a minimum number of intermediate hanger bearings. Where possible, they should be operated at relatively high speeds to help prevent fallback of the conveyed material.

Consult our Engineering Department for design recommendations and horsepower requirements for your particular application.

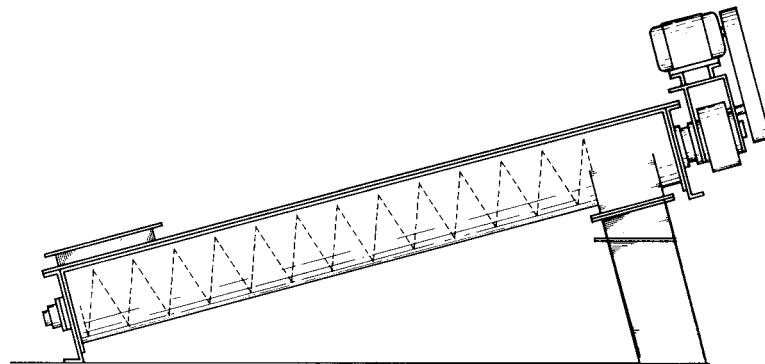

Vertical screw conveyors provide an efficient method of elevating most materials that can be conveyed in horizontal screw conveyors. Since vertical conveyors must be uniformly loaded in order to prevent choking, they are usually designed with integral feeders.

As with horizontal conveyors, vertical screw conveyors are available with many special features and accessories, including components of stainless steel or other alloys.

Consult our Engineering Department for design recommendations and horsepower requirements for your particular application.

SEE VERTICAL SCREW CONVEYOR SECTION OF CATALOG FOR ADDITIONAL INFORMATION.

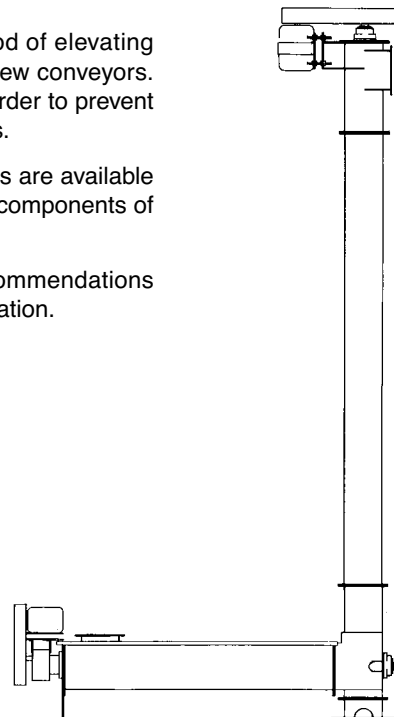

CONVEYORS

Vertical
Screw
Conveyors

Screw Feeders are designed to regulate the rate of material flow from a hopper or bin. The inlet is usually flooded with material (95% loaded). One or more tapered or variable pitch screws convey the material at the required rate. Screw feeders are regularly provided with shrouded or curved cover plates for a short distance beyond the end of the inlet opening, to obtain feed regulation. As the pitch or diameter increases beyond the shroud the level of the material in the conveyor drops to normal loading levels. Longer shrouds, extra short pitch screws and other modifications are occasionally required to reduce flushing of very free flowing material along the feeder screw.

Feeders are made in two general types: Type 1 with regular pitch flighting and Type 2 with short pitch flighting. Both types are also available with uniform diameter and tapering diameter screws. The various combinations are shown on pages H-34–H-35. Screw feeders with uniform screws, Types 1B, 1D, 2B, 2D are regularly used for handling fine free flowing materials. Since the diameter of the screw is uniform, the feed of the material will be from the forepart of the inlet and not across the entire length. Where hoppers, bins, tanks, etc. are to be completely emptied, or dead areas of material over the inlet are not objectionable, this type of feeder is entirely satisfactory, as well as economical. Screw feeders with tapering diameter screws will readily handle materials containing a fair percentage of lumps. In addition, they are used extensively where it is necessary or desirable to draw the material uniformly across the entire length of the inlet opening to eliminate inert or dead areas of material at the forepart of the opening. Types 1A, 1C, 2A, and 2C fall into this category. Variable pitch screws can be used in place of tapering diameter screws for some applications. They consist of screws with succeeding sectional flights increasing progressively in pitch. The portion of the screw with the smaller pitch is located under the inlet opening.

Screw feeders with extended screw conveyors are necessary when intermediate hangers are required, or when it is necessary to convey the material for some distance. A screw conveyor of larger diameter than the feeder screw is combined with the feeder to make the extension. See types 1C, 1D, 2C, 2D.

Multiple screw feeders are usually in flat bottom bins for discharging material which have a tendency to pack or bridge under pressure. Frequently, the entire bin bottom is provided with these feeders which convey the material to collecting conveyors. Such arrangements are commonly used for handling hogged fuel, wood shavings, etc.

Screw feeders are available in a variety of types to suit specific materials and applications. We recommend that you contact our Engineering Department for design information.

Screw Feeders

(For Inclined Applications Consult Factory)



Typical Type 1

Feeder Type	Inlet Opening	Material Removal	Pitch	Feeder Screw Diameter	Extended Screw
SF1A	Standard	Uniform Full Length of Inlet Opening	Standard	Tapered	None
SF1B	Standard	Forepart Only of Inlet Opening	Standard	Uniform	None
SF1C	Standard	Uniform Full Length of Inlet Opening	Standard	Tapered	As Required
SF1D	Standard	Forepart Only of Inlet Opening	Standard	Uniform	As Required

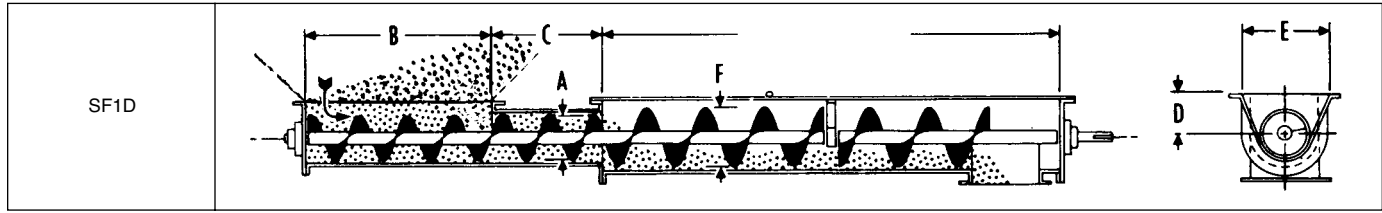
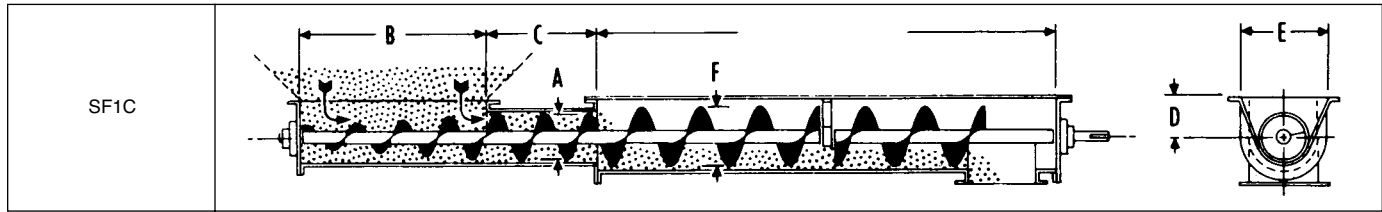
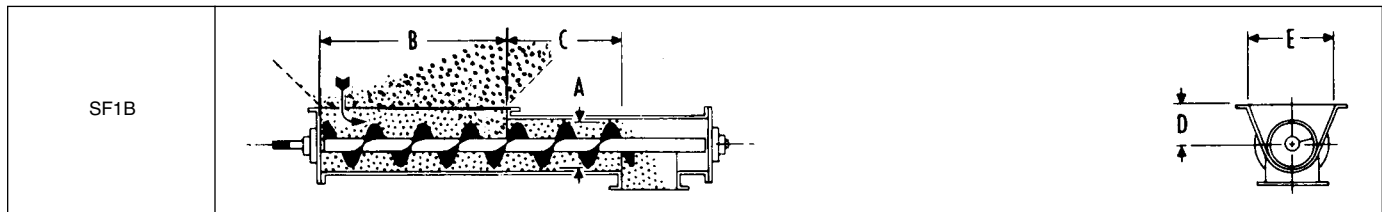
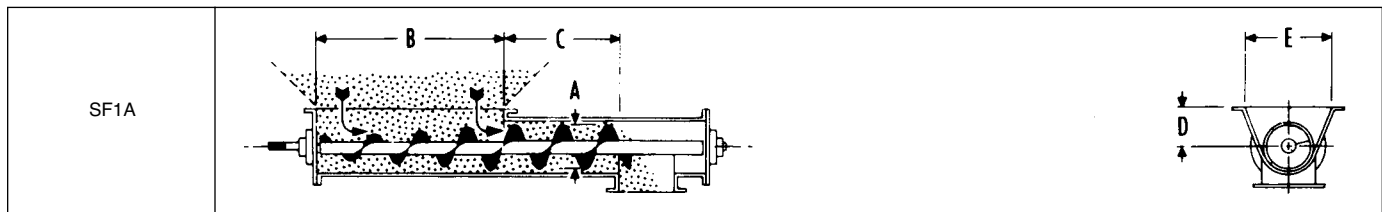

CONVEYORS

Feeder Diameter A	Maximum Lump Size	Maximum Speed RPM	Capacity Cubic Feet per Hour		B	C	D	E	Extended Screw Diameter F		
			At One RPM	At Maximum RPM					Trough Loading %		
									15	30	45
6	3/4"	70	4.8	336	36	12	7	14	12	9	9
9	1 1/2"	65	17	1105	42	18	9	18	18	14	12
12	2"	60	44	2640	48	24	10	22	24	18	16
14	2 1/2"	55	68	3740	54	28	11	24		20	18
16	3"	50	104	5200	56	32	11 1/2	28		24	20
18	3"	45	150	6750	58	36	12 1/2	31			24
20	3 1/2"	40	208	8320	60	40	13 1/2	34			
24	4"	30	340	10200	64	48	16 1/2	40			

*Consult factory if inlet exceeds these lengths.

Typical Type 2

Feeder Type	Inlet Opening	Material Removal	Pitch	Feeder Screw Diameter	Extended Screw
SF2A	Long	Uniform Full Length of Inlet Opening	Short (%)	Tapered	None
SF2B	Long	Forepart Only of Inlet Opening	Short (%)	Uniform	None
SF2C	Long	Uniform Full Length of Inlet Opening	Short (%)	Tapered	As Required
SF2D	Long	Forepart Only of Inlet Opening	Short (%) </tr		

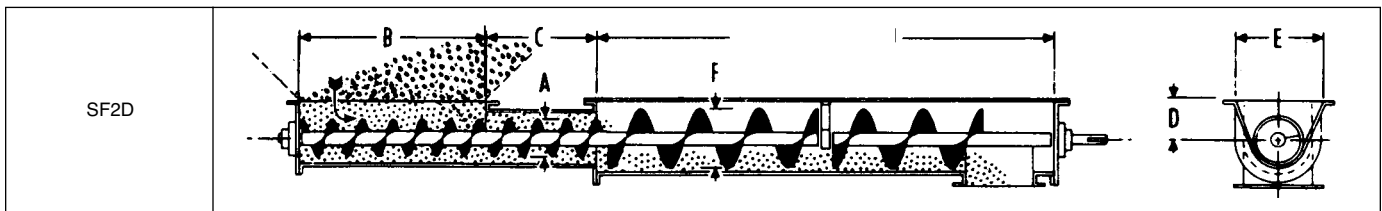
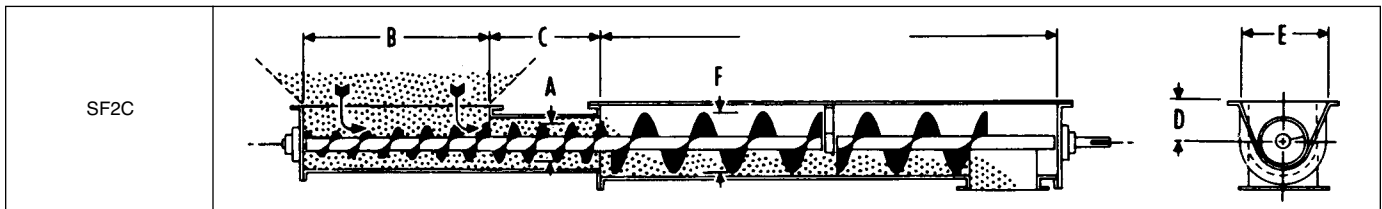
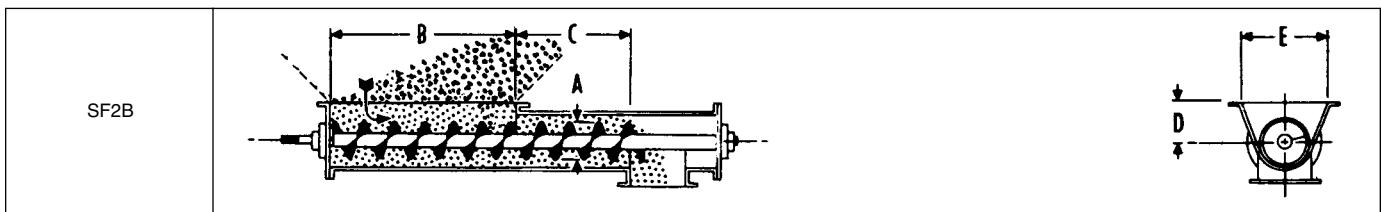
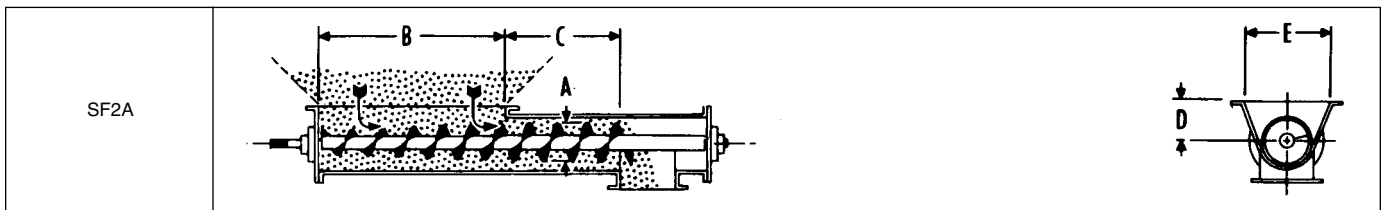

Feeder Diameter A	Maximum Lump Size	Maximum Speed RPM	Capacity Cubic Feet per Hour		B	C	D	E	Extended Screw Diameter F		
			At One RPM	At Maximum RPM					Trough Loading %		
									15	30	45
6	½"	70	3.1	217	60	18	7	14	10	9	9
9	¾"	65	11	715	66	26	9	18	14	12	10
12	1"	60	29	1740	72	36	10	22	20	16	14
14	1¼"	55	44	2420	76	42	11	24	24	18	16
16	1½"	50	68	3400	78	48	11½	28		20	18
18	1¾"	45	99	4455	80	54	12½	31		24	20
20	2"	40	137	5480	82	60	13½	34			24
24	2½"	30	224	6720	86	72	16½	40			

CONVEYORS

SECTION II

DESIGN AND LAYOUT SECTION II

Classification of Enclosure Types	H-36
Hand of Conveyors	H-38
Classification of Special Continuous Weld Finishes	H-39
Detailing of “U” Trough	H-40
Detailing of Tubular Trough	H-41
Detailing of Trough and Discharge Flanges	H-42
Bolt Tables	H-44
Pipe Sizes and Weights	H-46
Screw Conveyor Drive Arrangements	H-47
Standards Helicoid Screw	H-48
Standards Buttweld Screw	H-49
Screw Conveyor Sample Horsepower Worksheet	H-50

Classes of Enclosures

Conveyors can be designed to protect the material being handled from a hazardous surrounding or to protect the surroundings from a hazardous material being conveyed.

This section establishes recommended classes of construction for conveyor enclosures — without regard to their end use or application. These several classes call for specific things to be done to a standard conveyor housing to provide several degrees of enclosure protection.

Enclosure Classifications

- Class IE — Class IE enclosures are those provided primarily for the protection of operating personnel or equipment, or where the enclosure forms an integral or functional part of the conveyor or structure. They are generally used where dust control is not a factor or where protection for, or against, the material being handled is not necessary — although as conveyor enclosures a certain amount of protection is afforded.
- Class IIE — Class IIE enclosures employ constructions which provide some measure of protection against dust or for, or against, the material being handled.
- Class IIIIE — Class IIIIE enclosures employ constructions which provide a higher degree of protection in these classes against dust, and for or against the material being handled.
- Class IVE — Class IVE enclosures are for outdoor applications and under normal circumstances provide for the exclusion of water from the inside of the casing. They are not to be construed as being water-tight, as this may not always be the case.

When more than one method of fabrication is shown, either is acceptable.

Enclosure Construction				
Component Classification	Enclosure Classifications			
	I E	II E	III E	IV E
A. TROUGH CONSTRUCTION Formed & Angle Top Flange 1. Plate type end flange a. Continuous arc weld b. Continuous arc weld on top of end flange and trough top rail 2. Trough Top Rail Angles (Angle Top trough only) a. Staggered intermittent arc and spot weld b. Continuous arc weld on top leg of angle on inside of trough and intermittent arc weld on lower leg of angle to outside of trough c. Staggered intermittent arc weld on top leg of angle on inside of trough and intermittent arc weld on lower leg of angle to outside of trough, or spot weld when mastic is used between leg of angle and trough sheet				
B. COVER CONSTRUCTION 1. Plain flat a. Only butted when hanger is at cover joint b. Lapped when hanger is not at cover joint 2. Semi-Flanged a. Only butted when hanger is at cover joint b. Lapped when hanger is not at cover joint c. With buttstrap when hanger is not at cover joint 3. Flanged a. Only butted when hanger is at cover joint b. Buttstrap when hanger is not at cover joint 4. Hip Roof a. Ends with a buttstrap connection				
C. COVER FASTENERS FOR STANDARD GA. COVERS 1. Spring, screw or toggle clamp fasteners or bolted construction* a. Max. spacing plain flat covers b. Max. spacing semi-flanged covers c. Max. spacing flanged and hip-roof covers	60" 60"	30" 40"	18" 24"	18" 24"
D. GASKETS 1. Covers a. Red rubber or felt up to 230° F b. Neoprene rubber, when contamination is a problem c. Closed cell foam type elastic material to suit temperature rating of gasket 2. Trough End flanges a. Mastic type compounds b. Red rubber up to 230° F c. Neoprene rubber, when contamination is a problem d. Closed cell foam type elastic material to suit temperature rating of gasket				
E. TROUGH END SHAFT SEALS* 1. When handling non-abrasive materials 2. When handling abrasive materials *Lip type seals for non-abrasive materials Felt type for mildly abrasive materials Waste type for highly abrasive materials Waste type for moderately abrasive Air purged <i>Martin</i> Super Pac for extremely abrasive Bulk Heads may be required for abrasive & hot materials NOTE: CHECK MATERIAL TEMPERATURE.	X	X	X	X

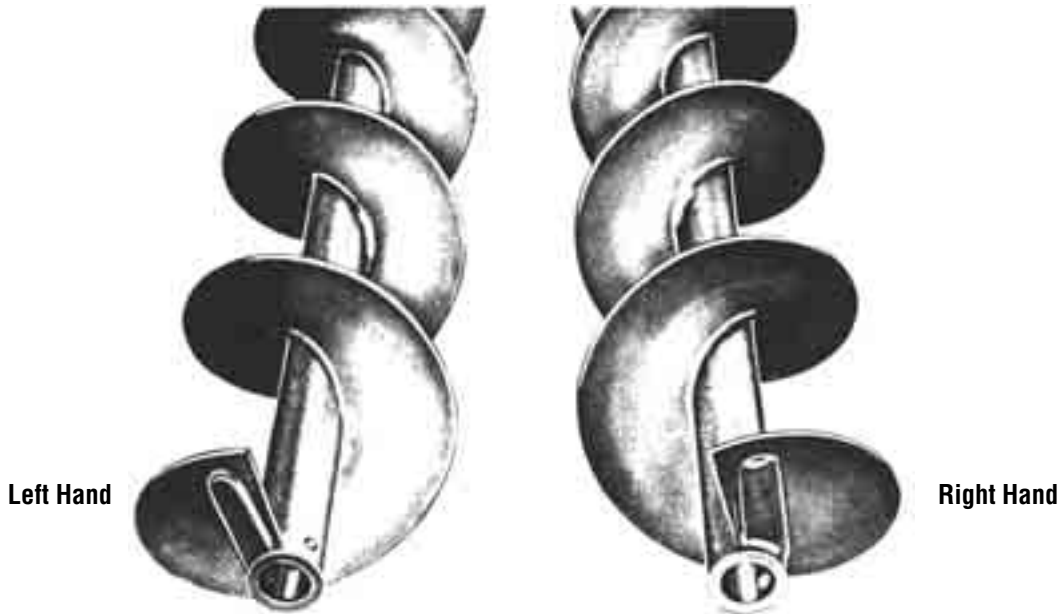

Right and Left Hand Screws

A conveyor screw is either right hand or left hand depending on the form of the helix. The hand of the screw is easily determined by looking at the end of the screw.

The screw pictured to the left has the flight helix wrapped around the pipe in a counter-clockwise direction, or to your left. Same as left hand threads on a bolt. This is arbitrarily termed a LEFT hand screw.

The screw pictured to the right has the flight helix wrapped around the pipe in a clockwise direction, or to your right. Same as right hand threads on a bolt. This is termed a RIGHT hand screw.

A conveyor screw viewed from either end will show the same configuration. If the end of the conveyor screw is not readily visible, then by merely imagining that the flighting has been cut, with the cut end exposed, the hand of the screw may be easily determined.

Conveyor Screw Rotation

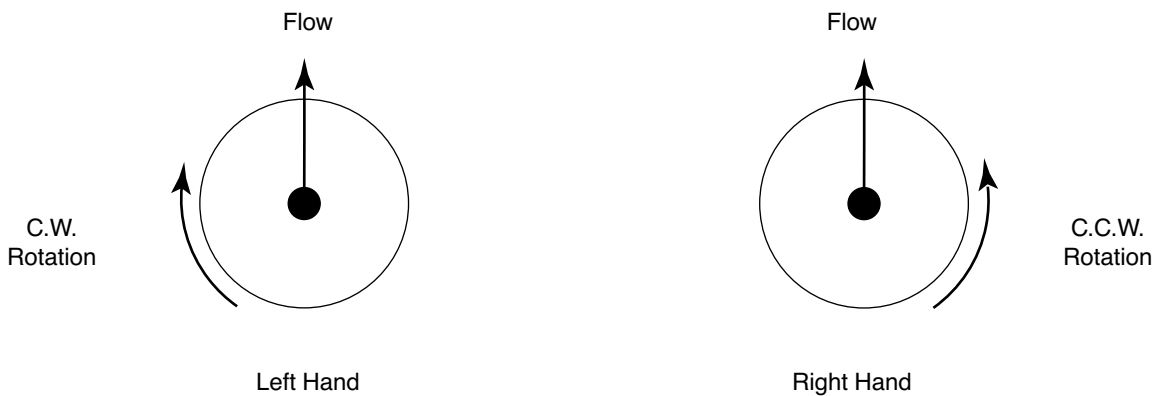

The above diagrams are a simple means of determining screw rotation. When the material flow is in the direction away from the end being viewed, a R.H. screw will turn counter clockwise and a L.H. screw will turn clockwise rotation as shown by the arrows.

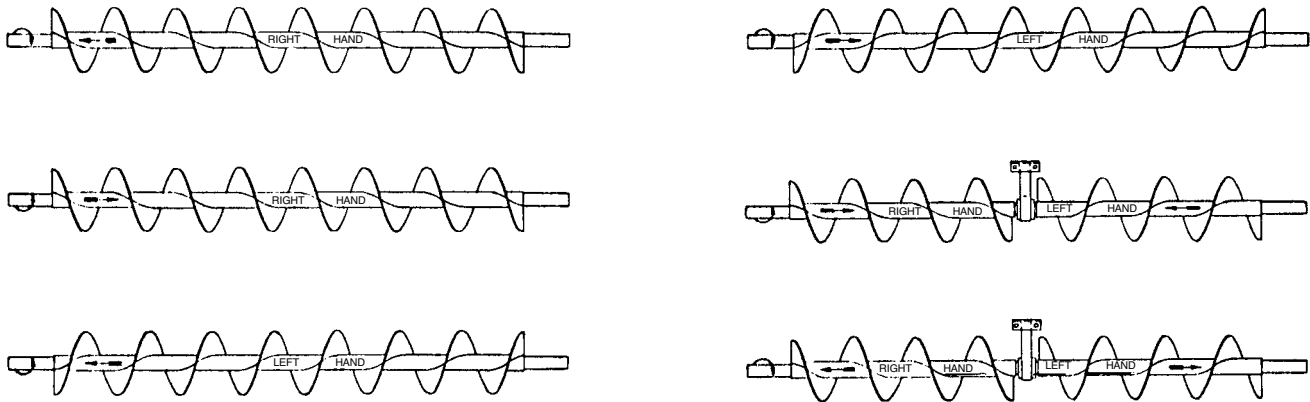

The above diagram indicates the hand of conveyor screw to use when direction of rotation and material flow are known.

Special Screw Conveyor Continuous Weld Finishes

Specifications on screw conveyor occasionally include the term “grind smooth” when referring to the finish on continuous welds. This specification is usually used for stainless steel, but occasionally it will appear in carbon steel specifications as well.

“Grind smooth” is a general term and subject to various interpretations. This Table establishes recommended classes of finishes, which should be used to help find the class required for an application.

Operation	Weld Finishes				
	I	II	III	IV	V
Weld spatter and slag removed	X	X	X	X	X
Rough grind welds to remove heavy weld ripple or unusual roughness (Equivalent to a 40-50 grit finish)		X			
Medium grind welds — leaving some pits and crevices (Equivalent to a 80-100 grit finish)			X		
Fine grind welds — no pits or crevices permissible (Equivalent to a 140-150 grit finish)				X	X
Polish to a bright uniform finish					X

Layout



Trough

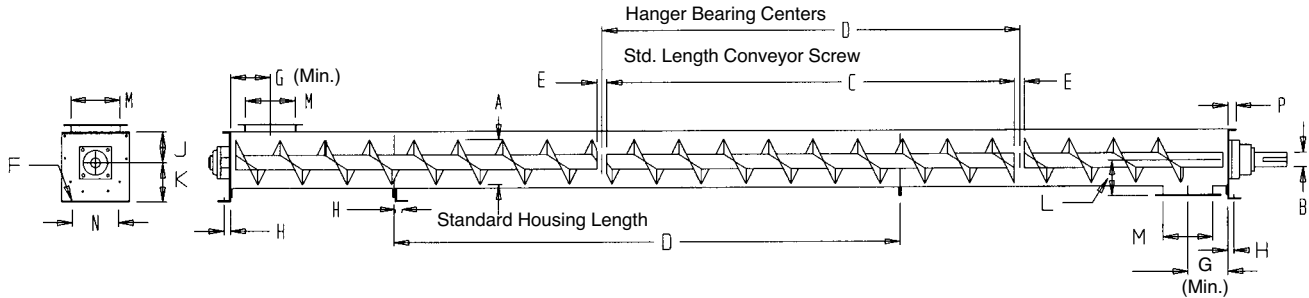

A Screw Diameter	B Coupling Diameter	C Length	D Length	E	F	G (Min.)	H	J	K	L	M	N	P	R
4	1	9-10½	10	1½	¾	4½	⅞	3⅝	4⅝	3¼	5	5¼	1⅞	1
6	1½	9-10	10	2	¾	6	1⅞	4½	5⅝	5	7	8⅝	1½	1
9	1½ 2	9-10	10	2	½	8	1⅞	6⅝	7⅞	7⅞	10	9⅝	1⅝	1½
10	1½ 2	9-10	10	2	½	9	1⅞	6⅝	8⅞	7⅞	11	9½	1¾	1¾
12	2 2⅞ 3	11-10 11-9 11-9	12	2 3 3	⅝	10½	1⅞	7⅞	9⅞	8⅞	13	12¼	2	1⅝
14	2⅞ 3	11-9	12	3	⅝	11½	1⅞	9⅞	10⅞	10⅞	15	13½	2	1⅝
16	3	11-9	12	3	⅝	13½	1⅞	10⅞	12	11⅞	17	14⅞	2½	2
18	3 3⅞	11-9 11-8	12	3 4	⅝	14½	1⅞	12⅞	13⅞	12⅞	19	16	2½	2
20	3 3⅞	11-9 11-8	12	3 4	¾	15½	2	13⅞	15	13⅞	21	19¼	2½	2¼
24	3⅞	11-8	12	4	¾	17½	2¼	16⅞	18⅞	15⅞	25	20	2½	2¼

Screw clearance at trough end is one half of dimension E

Typical Method of Detailing

9" x 2" x 25'-0" Conveyor

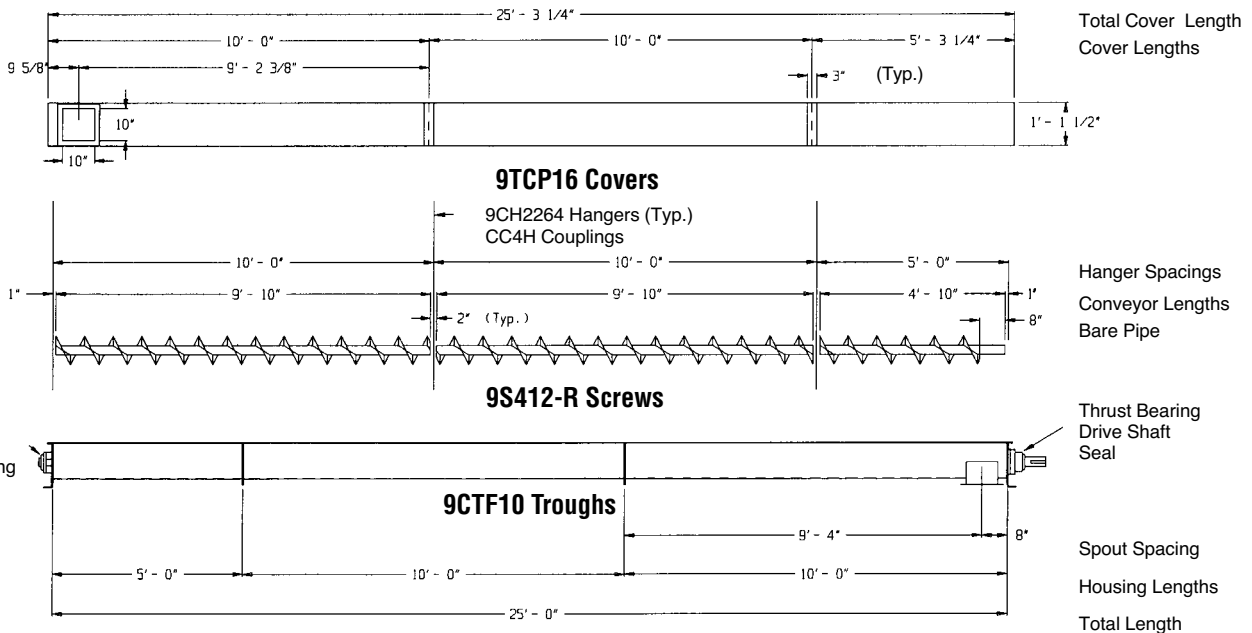

CONVEYORS

Tubular Housing

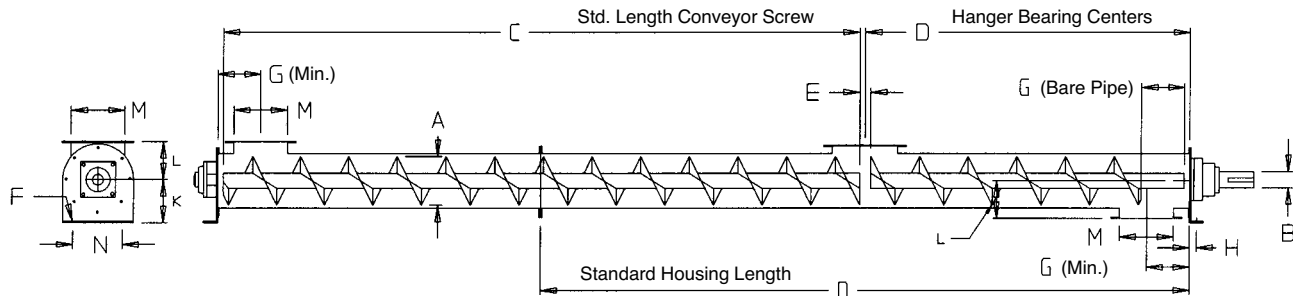

A Screw Dia.	B Coupling Dia.	C Length	D Length	E	F	G (Min.)	H	J	K	L	M	N	P	R
4	1	9-10½	10	1½	¾	4½	⅞	3⅝	4⅝	3¼	5	5¼	1⅞	1
6	1½	9-10	10	2	¾	6	1⅜	4½	5⅝	5	7	8⅝	1½	1
9	1½ 2	9-10	10	2	½	8	1⅞	6⅝	7⅞	7⅞	10	9⅝	1⅝	1½
10	1½ 2	9-10	10	2	½	9	1⅞	6⅝	8⅞	7⅞	11	9½	1¾	1¾
12	2 2⅞ 3	11-10 11-9 11-9	12	2 3 3	⅝	10½	1⅞	7⅞	9⅞	8⅞	13	12¼	2	1⅝
14	2⅞ 3	11-9	12	3	⅝	11½	1⅞	9⅞	10⅞	10⅞	15	13½	2	1⅝
16	3	11-9	12	3	⅝	13½	1⅞	10⅞	12	11⅞	17	14⅞	2½	2
18	3 3⅞	11-9 11-8	12	3 4	⅝	14½	1⅞	12⅞	13⅞	12⅞	19	16	2½	2
20	3 3⅞	11-9 11-8	12	3 4	¾	15½	2	13⅞	15	13⅞	21	19⅞	2½	2¼
24	3⅞	11-8	12	4	¾	17½	2¼	16⅞	18⅞	15⅞	25	20	2½	2¼

Screw clearance at trough end is one half of dimension E

Typical Method of Detailing

9" x 2" x 15'-0" Conveyor

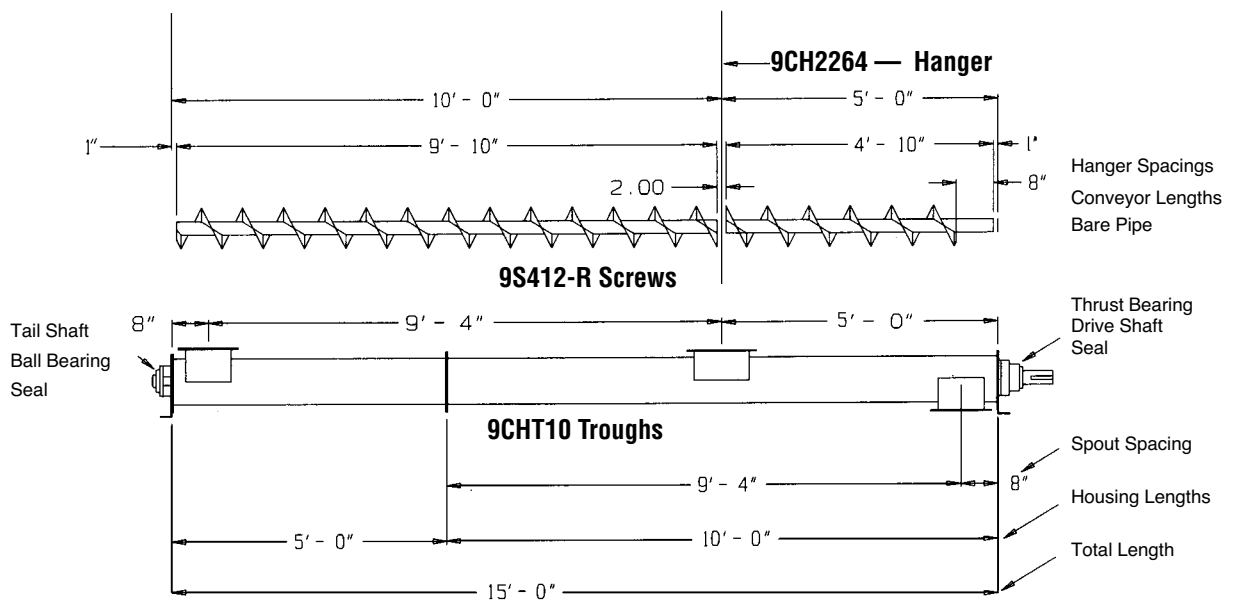

CONVEYORS

Bolt Patterns



U-Trough End Flanges

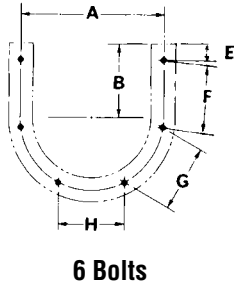

6 Bolts

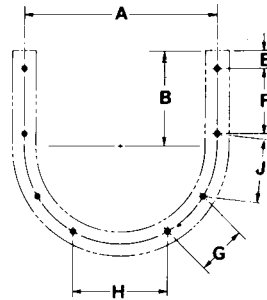

8 Bolts

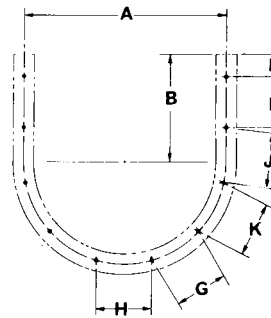

10 Bolts

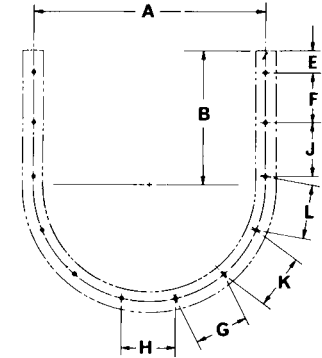

12 Bolts

Screw Diameter	Bolts		A	B	E	F	G	H	J	K	L
	Number	Diameter									
4	6	$\frac{3}{8}$	7	$3\frac{3}{8}$	$1\frac{1}{8}$	$3\frac{3}{8}$	$3\frac{3}{8}$	$3\frac{3}{8}$	X	X	X
6	6	$\frac{3}{8}$	$8\frac{7}{8}$	$4\frac{1}{2}$	$1\frac{1}{32}$	$4\frac{1}{8}$	$4\frac{1}{16}$	$4\frac{1}{16}$	X	X	X
9	8	$\frac{3}{8}$	$12\frac{1}{2}$	$6\frac{1}{8}$	$1\frac{3}{16}$	$4\frac{1}{8}$	$3\frac{3}{4}$	$5\frac{1}{8}$	$4\frac{1}{8}$	X	X
10	8	$\frac{3}{8}$	$13\frac{1}{4}$	$6\frac{3}{8}$	$2\frac{1}{4}$	$3\frac{1}{2}$	$4\frac{3}{16}$	$5\frac{1}{16}$	$4\frac{1}{8}$	X	X
12	8	$\frac{1}{2}$	$15\frac{5}{8}$	$7\frac{3}{4}$	$1\frac{1}{2}$	$5\frac{5}{16}$	$4\frac{1}{16}$	$7\frac{3}{4}$	$5\frac{5}{16}$	X	X
14	8	$\frac{1}{2}$	$17\frac{7}{8}$	$9\frac{1}{4}$	$2\frac{17}{32}$	$5\frac{1}{8}$	$5\frac{1}{16}$	6	$5\frac{1}{16}$	X	X
16	8	$\frac{5}{8}$	20	$10\frac{5}{8}$	$2\frac{3}{8}$	$6\frac{3}{8}$	$6\frac{3}{8}$	$7\frac{1}{2}$	$6\frac{3}{8}$	X	X
18	10	$\frac{5}{8}$	22	12 $\frac{1}{2}$	$2\frac{29}{32}$	$5\frac{1}{16}$	$5\frac{1}{8}$	$5\frac{1}{8}$	$5\frac{1}{8}$	$5\frac{1}{8}$	X
20	10	$\frac{5}{8}$	$24\frac{3}{8}$	$13\frac{1}{2}$	$2\frac{25}{32}$	$6\frac{1}{4}$	$6\frac{1}{16}$	$6\frac{1}{16}$	$6\frac{1}{16}$	$6\frac{1}{16}$	X
24	12	$\frac{5}{8}$	$28\frac{1}{2}$	$16\frac{1}{2}$	$2\frac{25}{32}$	$6\frac{1}{8}$	$6\frac{3}{8}$	$6\frac{3}{8}$	$6\frac{3}{8}$	$6\frac{3}{8}$	$6\frac{3}{8}$

Flared Trough End Flanges

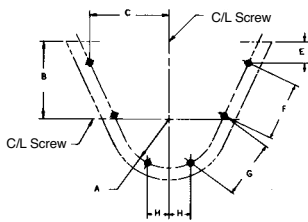

6 Bolts

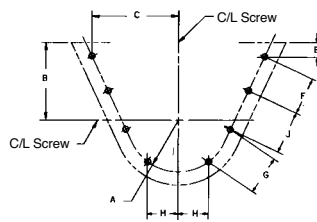

8 Bolts

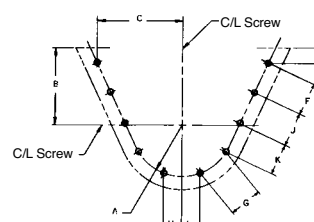

10 Bolts

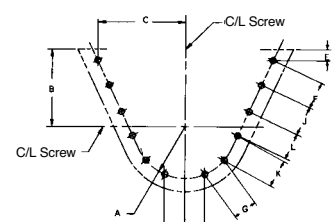

12 Bolts

Screw Diameter Inches	Bolts		A	B	C	E	F	G	H	J	K	L
	Diameter Number	Holes										
6	$\frac{3}{8}$	6	$4\frac{7}{16}$	7	$7\frac{7}{16}$	$1\frac{27}{32}$	$5\frac{1}{4}$	$5\frac{1}{4}$	$2\frac{1}{32}$	—	—	—
9	$\frac{3}{8}$	8	$6\frac{1}{4}$	9	$9\frac{21}{32}$	$1\frac{1}{64}$	5	5	$2\frac{1}{16}$	5	—	—
12	$\frac{1}{2}$	8	$7\frac{15}{16}$	10	$11\frac{13}{16}$	$1\frac{1}{16}$	$5\frac{1}{4}$	$5\frac{1}{4}$	$3\frac{3}{8}$	$5\frac{1}{4}$	—	—
14	$\frac{1}{2}$	10	$8\frac{15}{16}$	11	$12\frac{49}{64}$	$2\frac{1}{16}$	$5\frac{1}{8}$	$5\frac{1}{8}$	3	$5\frac{1}{8}$	$5\frac{1}{8}$	—
16	$\frac{5}{8}$	10	10	$11\frac{1}{2}$	$14\frac{11}{16}$	$2\frac{1}{64}$	$5\frac{1}{2}$	$5\frac{1}{2}$	$3\frac{3}{4}$	$5\frac{1}{2}$	$5\frac{1}{2}$	—
18	$\frac{5}{8}$	10	11	$12\frac{1}{2}$	16	$2\frac{3}{8}$	$6\frac{1}{16}$	$6\frac{1}{16}$	$2\frac{1}{16}$	$6\frac{1}{16}$	$6\frac{1}{16}$	—
20	$\frac{5}{8}$	10	$12\frac{3}{16}$	$13\frac{1}{2}$	$17\frac{1}{8}$	$2\frac{3}{32}$	7	7	$3\frac{1}{32}$	7	7	—
24	$\frac{5}{8}$	12	$14\frac{1}{4}$	$16\frac{1}{2}$	$20\frac{61}{64}$	$2\frac{1}{16}$	$6\frac{3}{8}$	$6\frac{3}{8}$	$3\frac{1}{16}$	$6\frac{3}{8}$	$6\frac{3}{8}$	$6\frac{3}{8}$

Tubular Housing Flanges

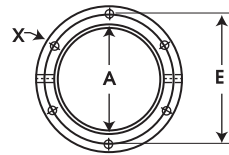

6 bolts

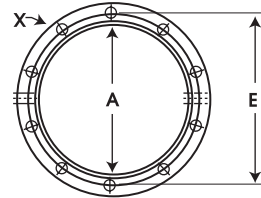

10 bolts

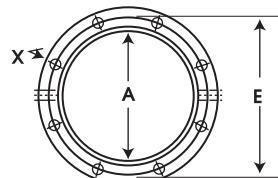

8 bolts

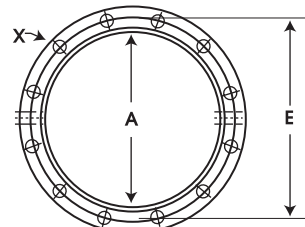

12 bolts

Intake & Discharge Flanges

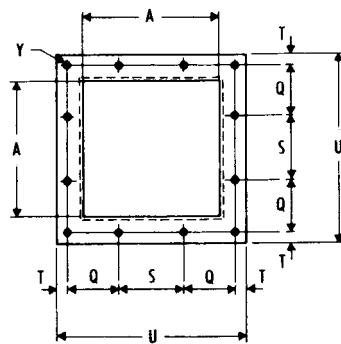

12 bolts

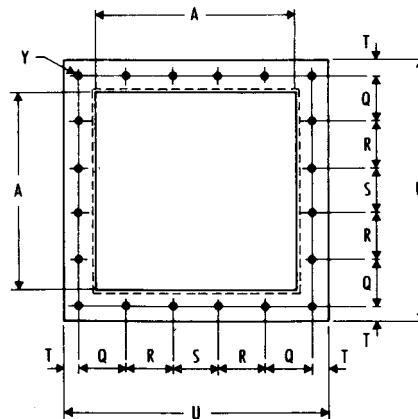

20 bolts

Screw Size	Flange Bolts		A	E	Q	R	S	T	U
	Tubular X	Discharge Y							
4	6-- ³ / ₈	12-- ¹ / ₄	5	7	2 ¹ / ₄	—	2 ¹ / ₄	³ / ₈	7 ¹ / ₂
6	8-- ³ / ₈	12-- ³ / ₈	7	8 ³ / ₈	2 ¹⁵ / ₁₆	—	3	¹ / ₁₆	10
9	8-- ³ / ₈	12-- ³ / ₈	10	11 ¹ / ₈	4	—	4	¹ / ₂	13
10	8-- ³ / ₈	12-- ³ / ₈	11	13 ¹ / ₄	4 ⁵ / ₁₆	—	4 ³ / ₈	⁵ / ₈	14 ¹ / ₄
12	8-- ¹ / ₂	12-- ³ / ₈	13	15	5 ⁵ / ₈	—	5 ¹ / ₄	⁷ / ₈	17 ¹ / ₄
14	8-- ¹ / ₂	20-- ³ / ₈	15	17	3 ¹ / ₂	3 ¹ / ₂	3 ¹ / ₂	⁷ / ₈	19 ¹ / ₄
16	8-- ⁵ / ₈	20-- ³ / ₈	17	19 ¹ / ₂	3 ³ / ₄	4	4	⁷ / ₈	21 ¹ / ₄
18	10-- ⁵ / ₈	20-- ¹ / ₂	19	22	4 ⁷ / ₁₆	4 ³ / ₈	4 ³ / ₈	1 ¹ / ₈	24 ¹ / ₄
20	10-- ⁵ / ₈	20-- ¹ / ₂	21	24 ³ / ₈	4 ⁷ / ₈	4 ³ / ₄	4 ³ / ₄	1 ¹ / ₈	26 ¹ / ₄
24	12-- ⁵ / ₈	20-- ¹ / ₂	25	28 ¹ / ₂	5 ⁵ / ₈	5 ⁵ / ₈	5 ¹ / ₂	1 ¹ / ₈	30 ¹ / ₄

Bolt Requirements



Part Name		Bolt Requirements Related to Conveyor Trough Sizes													
		4	6	9	10	12	14	16	18	20	24				
Flange, Trough	Notes	6- ³ / ₄ x 1	6- ³ / ₄ x 1	8- ³ / ₄ x 1	8- ³ / ₄ x 1	8- ¹ / ₂ x 1 ¹ / ₄	8- ¹ / ₂ x 1 ¹ / ₄	8- ¹ / ₂ x 1 ¹ / ₄	8- ¹ / ₂ x 1 ¹ / ₄	8- ¹ / ₂ x 1 ¹ / ₄	8- ¹ / ₂ x 1 ¹ / ₄	8- ¹ / ₂ x 1 ¹ / ₄	10- ³ / ₁₆ x 1 ¹ / ₂	12- ⁵ / ₁₆ x 1 ¹ / ₂	
	Flange, Tubular Housing	6- ³ / ₄ x 1	8- ³ / ₄ x 1	8- ³ / ₄ x 1	8- ³ / ₄ x 1	8- ¹ / ₂ x 1 ¹ / ₄	8- ¹ / ₂ x 1 ¹ / ₄	8- ¹ / ₂ x 1 ¹ / ₄	8- ¹ / ₂ x 1 ¹ / ₄	8- ¹ / ₂ x 1 ¹ / ₄	8- ¹ / ₂ x 1 ¹ / ₄	8- ¹ / ₂ x 1 ¹ / ₄	10- ³ / ₁₆ x 1 ¹ / ₂	12- ⁵ / ₁₆ x 1 ¹ / ₂	
Ends, Trough	Inside	6- ¹ / ₄ x ³ / ₄	6- ⁵ / ₁₆ x ³ / ₄	8- ³ / ₄ x 1	8- ³ / ₄ x 1	8- ¹ / ₂ x 1	8- ¹ / ₂ x 1 ¹ / ₄	8- ¹ / ₂ x 1 ¹ / ₄	8- ¹ / ₂ x 1 ¹ / ₄	8- ¹ / ₂ x 1	8- ¹ / ₂ x 1 ¹ / ₄	8- ¹ / ₂ x 1 ¹ / ₄	10- ³ / ₁₆ x 1 ¹ / ₂	12- ⁵ / ₁₆ x 1 ¹ / ₂	
	Inside Discharge	2- ¹ / ₄ x ³ / ₄	2- ⁵ / ₁₆ x ³ / ₄	4- ³ / ₄ x 1	4- ³ / ₄ x 1	4- ¹ / ₂ x 1	4- ¹ / ₂ x 1 ¹ / ₄	4- ¹ / ₂ x 1 ¹ / ₄	4- ¹ / ₂ x 1 ¹ / ₄	4- ¹ / ₂ x 1	4- ¹ / ₂ x 1 ¹ / ₄	4- ¹ / ₂ x 1 ¹ / ₄	4- ³ / ₁₆ x 1 ¹ / ₂	6- ⁵ / ₁₆ x 1 ¹ / ₂	
	Inside Rectangular	5- ¹ / ₄ x ³ / ₄	6- ⁵ / ₁₆ x ³ / ₄	8- ³ / ₄ x 1	8- ³ / ₄ x 1	10- ¹ / ₂ x 1	11- ¹ / ₂ x 1 ¹ / ₄	12- ⁵ / ₁₆ x 1 ¹ / ₄	12- ⁵ / ₁₆ x 1 ¹ / ₄	12- ⁵ / ₁₆ x 1 ¹ / ₄	10- ³ / ₁₆ x 1 ¹ / ₂	10- ³ / ₁₆ x 1 ¹ / ₂	10- ³ / ₁₆ x 1 ¹ / ₂	12- ⁵ / ₁₆ x 1 ¹ / ₂	12- ⁵ / ₁₆ x 1 ¹ / ₂
	Outside Type	6- ³ / ₄ x 1	6- ³ / ₄ x 1	8- ³ / ₄ x 1	8- ³ / ₄ x 1	8- ¹ / ₂ x 1 ¹ / ₄	8- ¹ / ₂ x 1 ¹ / ₄	8- ¹ / ₂ x 1 ¹ / ₄	8- ¹ / ₂ x 1 ¹ / ₄	8- ¹ / ₂ x 1 ¹ / ₄	8- ¹ / ₂ x 1 ¹ / ₄	8- ¹ / ₂ x 1 ¹ / ₄	10- ³ / ₁₆ x 1 ¹ / ₂	12- ⁵ / ₁₆ x 1 ¹ / ₂	
	Outside Discharge	2- ³ / ₄ x 1	2- ³ / ₄ x 1	4- ³ / ₄ x 1	4- ³ / ₄ x 1	4- ¹ / ₂ x 1 ¹ / ₄	4- ¹ / ₂ x 1 ¹ / ₄	4- ¹ / ₂ x 1 ¹ / ₄	4- ¹ / ₂ x 1 ¹ / ₄	4- ¹ / ₂ x 1 ¹ / ₄	4- ¹ / ₂ x 1 ¹ / ₄	4- ¹ / ₂ x 1 ¹ / ₄	4- ¹ / ₂ x 1 ¹ / ₄	4- ³ / ₁₆ x 1 ¹ / ₂	6- ⁵ / ₁₆ x 1 ¹ / ₂
	Ends, Tubular Housing	6- ³ / ₄ x 1	8- ³ / ₄ x 1	8- ³ / ₄ x 1	8- ³ / ₄ x 1	8- ¹ / ₂ x 1 ¹ / ₄	8- ¹ / ₂ x 1 ¹ / ₄	8- ¹ / ₂ x 1 ¹ / ₄	8- ¹ / ₂ x 1 ¹ / ₄	8- ¹ / ₂ x 1 ¹ / ₄	8- ¹ / ₂ x 1 ¹ / ₄	8- ¹ / ₂ x 1 ¹ / ₄	8- ¹ / ₂ x 1 ¹ / ₄	10- ³ / ₁₆ x 1 ¹ / ₂	12- ⁵ / ₁₆ x 1 ¹ / ₂
Hanger, Trough	Style 60		2- ¹ / ₂ x 2	2- ¹ / ₂ x 2	2- ¹ / ₂ x 2	2- ¹ / ₂ x 2 ¹ / ₂	2- ¹ / ₂ x 2 ¹ / ₂	2- ¹ / ₂ x 2 ¹ / ₂	2- ¹ / ₂ x 2 ¹ / ₂	2- ¹ / ₂ x 2 ¹ / ₂	2- ¹ / ₂ x 2 ¹ / ₂	2- ¹ / ₂ x 2 ¹ / ₂	2- ⁵ / ₁₆ x 2 ¹ / ₂	2- ⁵ / ₁₆ x 2 ¹ / ₂	
	Style 70		4- ³ / ₄ x 1	4- ³ / ₄ x 1 ¹ / ₄	4- ³ / ₄ x 1 ¹ / ₄	4- ¹ / ₂ x 1 ¹ / ₂	4- ¹ / ₂ x 1 ¹ / ₂	4- ¹ / ₂ x 1 ¹ / ₂	4- ¹ / ₂ x 1 ¹ / ₂	4- ¹ / ₂ x 1 ¹ / ₂	4- ¹ / ₂ x 1 ¹ / ₂	4- ¹ / ₂ x 1 ¹ / ₂	4- ¹ / ₂ x 1 ¹ / ₂	4- ¹ / ₂ x 1 ¹ / ₂	
	Style 216		4- ³ / ₄ x 1 ¹ / ₄	4- ³ / ₄ x 1 ¹ / ₄	4- ³ / ₄ x 1 ¹ / ₄	4- ³ / ₄ x 1 ¹ / ₄	4- ³ / ₄ x 1 ¹ / ₄	4- ³ / ₄ x 1 ¹ / ₄	4- ³ / ₄ x 1 ¹ / ₄	4- ³ / ₄ x 1 ¹ / ₄	4- ³ / ₄ x 1 ¹ / ₄	4- ³ / ₄ x 1 ¹ / ₄	4- ³ / ₄ x 1 ¹ / ₄	4- ³ / ₄ x 1 ¹ / ₄	
	Style 220	4- ¹ / ₄ x 1	4- ³ / ₄ x 1	4- ³ / ₄ x 1	4- ³ / ₄ x 1	4- ¹ / ₂ x 1 ¹ / ₂	4- ¹ / ₂ x 1 ¹ / ₂	4- ¹ / ₂ x 1 ¹ / ₂	4- ¹ / ₂ x 1 ¹ / ₂	4- ¹ / ₂ x 1 ¹ / ₂	4- ¹ / ₂ x 1 ¹ / ₂	4- ¹ / ₂ x 1 ¹ / ₂	4- ¹ / ₂ x 1 ¹ / ₂	4- ¹ / ₂ x 1 ¹ / ₂	
	Style 226	4- ¹ / ₄ x 1	4- ³ / ₄ x 1 ¹ / ₄	4- ³ / ₄ x 1 ¹ / ₄	4- ³ / ₄ x 1 ¹ / ₄	4- ¹ / ₂ x 1 ¹ / ₂	4- ¹ / ₂ x 1 ¹ / ₂	4- ¹ / ₂ x 1 ¹ / ₂	4- ¹ / ₂ x 1 ¹ / ₂	4- ¹ / ₂ x 1 ¹ / ₂	4- ¹ / ₂ x 1 ¹ / ₂	4- ¹ / ₂ x 1 ¹ / ₂	4- ¹ / ₂ x 1 ¹ / ₂	4- ¹ / ₂ x 1 ¹ / ₂	
	Style 230		4- ³ / ₄ x 1	4- ³ / ₄ x 1	4- ³ / ₄ x 1	4- ¹ / ₂ x 1 ¹ / ₂	4- ¹ / ₂ x 1 ¹ / ₂	4- ¹ / ₂ x 1 ¹ / ₂	4- ¹ / ₂ x 1 ¹ / ₂	4- ¹ / ₂ x 1 ¹ / ₂	4- ¹ / ₂ x 1 ¹ / ₂	4- ¹ / ₂ x 1 ¹ / ₂	4- ¹ / ₂ x 1 ¹ / ₂	4- ¹ / ₂ x 1 ¹ / ₂	
	Style 316	4- ¹ / ₄ x 1	4- ³ / ₄ x 1	4- ³ / ₄ x 1	4- ³ / ₄ x 1	4- ¹ / ₂ x 1 ¹ / ₂	4- ¹ / ₂ x 1 ¹ / ₂	4- ¹ / ₂ x 1 ¹ / ₂	4- ¹ / ₂ x 1 ¹ / ₂	4- ¹ / ₂ x 1 ¹ / ₂	4- ¹ / ₂ x 1 ¹ / ₂	4- ¹ / ₂ x 1 ¹ / ₂	4- ¹ / ₂ x 1 ¹ / ₂	4- ¹ / ₂ x 1 ¹ / ₂	
	Style 326	4- ¹ / ₄ x 1	4- ³ / ₄ x 1	4- ³ / ₄ x 1	4- ³ / ₄ x 1	4- ¹ / ₂ x 1 ¹ / ₂	4- ¹ / ₂ x 1 ¹ / ₂	4- ¹ / ₂ x 1 ¹ / ₂	4- ¹ / ₂ x 1 ¹ / ₂	4- ¹ / ₂ x 1 ¹ / ₂	4- ¹ / ₂ x 1 ¹ / ₂	4- ¹ / ₂ x 1 ¹ / ₂	4- ¹ / ₂ x 1 ¹ / ₂	4- ¹ / ₂ x 1 ¹ / ₂	
Covers, Trough (Std. 10 ft.)		10- ⁵ / ₁₆ x ³ / ₄	10- ⁵ / ₁₆ x ³ / ₄	10- ⁵ / ₁₆ x ³ / ₄	10- ⁵ / ₁₆ x ³ / ₄	10- ⁵ / ₁₆ x ³ / ₄	10- ⁵ / ₁₆ x ³ / ₄	10- ⁵ / ₁₆ x ³ / ₄	10- ⁵ / ₁₆ x ³ / ₄	10- ⁵ / ₁₆ x ³ / ₄	10- ⁵ / ₁₆ x ³ / ₄	10- ⁵ / ₁₆ x ³ / ₄	10- ⁵ / ₁₆ x ³ / ₄	10- ⁵ / ₁₆ x ³ / ₄	
Saddle — Feet	Flanged Feet	2- ³ / ₄ x 1 ¹ / ₄	2- ³ / ₄ x 1 ¹ / ₄	2- ³ / ₄ x 1 ¹ / ₄	2- ³ / ₄ x 1 ¹ / ₄	2- ¹ / ₂ x 1 ¹ / ₂	2- ¹ / ₂ x 1 ¹ / ₂	2- ¹ / ₂ x 1 ¹ / ₂	2- ¹ / ₂ x 1 ¹ / ₂	2- ¹ / ₂ x 1 ¹ / ₂	2- ¹ / ₂ x 1 ¹ / ₂	2- ¹ / ₂ x 1 ¹ / ₂	2- ⁵ / ₁₆ x 1 ³ / ₄	2- ⁵ / ₁₆ x 1 ³ / ₄	
	Saddle	2- ¹ / ₄ x 1	2- ¹ / ₄ x 1	2- ³ / ₈ x 1	2- ³ / ₈ x 1	2- ¹ / ₂ x 1 ¹ / ₄	2- ¹ / ₂ x 1 ¹ / ₄	2- ¹ / ₂ x 1 ¹ / ₄	2- ¹ / ₂ x 1 ¹ / ₄	2- ¹ / ₂ x 1 ¹ / ₄	2- ¹ / ₂ x 1 ¹ / ₄	2- ¹ / ₂ x 1 ¹ / ₄	2- ⁵ / ₁₆ x 1 ¹ / ₄	2- ⁵ / ₁₆ x 1 ¹ / ₄	
Spouts, Discharge	Attaching Bolts	8- ³ / ₄ x 1 ¹ / ₂	8- ³ / ₄ x 1 ¹ / ₂	8- ³ / ₄ x 1 ¹ / ₂	8- ³ / ₄ x 1 ¹ / ₂	8- ³ / ₄ x 1 ¹ / ₂	8- ³ / ₄ x 1 ¹ / ₂	8- ³ / ₄ x 1 ¹ / ₂	8- ³ / ₄ x 1 ¹ / ₂	8- ³ / ₄ x 1 ¹ / ₂	8- ³ / ₄ x 1 ¹ / ₂	8- ³ / ₄ x 1 ¹ / ₂	12- ¹ / ₂ x 1 ¹ / ₂	12- ¹ / ₂ x 1 ¹ / ₂	
	Flange	12- ³ / ₄ x 1	12- ³ / ₄ x 1	12- ³ / ₄ x 1	12- ³ / ₄ x 1	12- ³ / ₄ x 1	20- ³ / ₈ x 1	20- ³ / ₈ x 1	20- ³ / ₈ x 1	12- ³ / ₄ x 1	20- ³ / ₈ x 1	20- ³ / ₈ x 1	20- ¹ / ₂ x 1	20- ¹ / ₂ x 1	
	Flange w/Slide	10- ³ / ₄ x 1	10- ³ / ₄ x 1	10- ³ / ₄ x 1	10- ³ / ₄ x 1	10- ³ / ₄ x 1	16- ³ / ₈ x 1	16- ³ / ₈ x 1	16- ³ / ₈ x 1	10- ³ / ₄ x 1	16- ³ / ₈ x 1	16- ³ / ₈ x 1	16- ¹ / ₂ x 1 ¹ / ₄	16- ¹ / ₂ x 1 ¹ / ₄	

All bolts hex head cap screws with hex nuts and lock washers.

Part Name	Bolt Requirements Related to Shaft Coupling Sizes					
	1	1½	2	2½	3	3½
Bearings, End						
Discharge Bronze	3-¾ x 1¼	3-½ x 1½	3-½ x 1¼	3-½ x 1¼	3-¾ x 2	3-¾ x 2¼
Discharge Ball	3-¾ x 1¼	3-½ x 1½	3-½ x 1¼	3-½ x 1¼	3-¾ x 2	3-¾ x 2¼
Flanged Bronze	4-¾ x 1¼	4-½ x 1½	4-½ x 1¼	4-½ x 1¼	4-¾ x 2	4-¾ x 2¼
Flanged Ball	4-¾ x 1¼	4-½ x 1½	4-½ x 1¼	4-½ x 1¼	4-¾ x 2	4-¾ x 2¼
Flanged Roller		4-½ x 2	4-½ x 2¼	4-½ x 2½	4-¾ x 2¼	4-¾ x 3¼
Pillow Block Bronze	2-¾ x 1½	2-½ x 1¾	2-½ x 2	2-½ x 2¼	2-¾ x 2½	2-¾ x 2¾
Pillow Block Ball	2-¾ x 1¾	2-½ x 2¼	2-½ x 2¼	2-½ x 2¼	2-¾ x 3½	2-¾ x 3¾
Pillow Block, Roller		2-½ x 2¼	2-½ x 2½	2-½ x 2¾	2-¾ x 3	2-¾ x 3½
Bearings, Thrust						
Type "E" Roller		4-½ x 2¾	4-½ x 2¾	4-½ x 3¼	4-¾ x 3½	4-¾ x 3¾
Coupling Bolts	¾ x 2½	½ x 3	¾ x 3¾	¾ x 4¾	¾ x 5-3½" Pipe ¾ x 5½-4" Pipe	¾ x 5½
Seals, Shafts						
Flanged Gland		4-½ x 1½	4-½ x 1½	4-½ x 1½	4-¾ x 1¼	4-¾ x 1¾
Plate w/Ball or Bronze		4-½ x 2	4-½ x 2¼	4-½ x 2¼	4-¾ x 2¼	4-¾ x 3
Plate w/Roller		4-½ x 2¼	4-½ x 2¾	4-½ x 3	4-¾ x 3¼	4-¾ x 3¾
Split Gland		2-½ x 1½	2-½ x 1½	2-½ x 1¾	2-¾ x 1¼	2-¾ x 2¼
Waste Pack, w/Ball or Bronze		4-½ x 3¼	4-½ x 3½	4-½ x 3¾	4-¾ x 4	4-¾ x 4¾
Waste Pack, w/Roller		4-½ x 3¾	4-½ x 4	4-½ x 4	4-¾ x 4¼	4-¾ x 4½

*See page H-87 for special coupling bolts.
All other bolts hex head cap screws with hex nuts and lock washers.

Pipe Sizes, Dimensions and Weights

Nominal Pipe Size Inches	Outside Diameter Inches	I.P.S. Schedule	Wall Inches	Inside Diameter Inches	Wt./Ft. Pounds	Nominal Pipe Size Inches	Outside Diameter Inches	I.P.S. Schedule	Wall Inches	Inside Diameter Inches	Wt./Ft. Pounds
⅝	.405	10S	.049	.307	.1863	3	3.500	5S	.083	3.334	3.029
		40 40S Est.	.068	.269	.2447			10S	.120	3.260	4.332
		80 80S Ex. Hvy.	.095	.215	.3145			40 40S Est.	.216	3.068	7.576
¾	.540	10S	.065	.410	.3297	3½	4.000	80 80S Ex. Hvy.	.300	2.900	10.25
		40 40S Est.	.088	.364	.4248			160	.438	2.624	14.32
		80 80S Ex. Hvy.	.119	.302	.5351			XX Hvy.	.600	2.300	18.58
⅞	.675	10S	.065	.545	.4235	4	4.500	5S	.083	3.834	3.472
		40 40S Std.	.091	.493	.5676			10S	.120	3.760	4.973
		80 80S Ex. Hvy.	.126	.423	.7388			40 40S Std.	.226	3.548	9.109
1	.840	5S	.065	.710	.5383	5	5.563	80 80S Ex. Hvy.	.318	3.364	12.50
		10S	.083	.674	.6710			5S	.109	5.345	6.349
		40 40S Est.	.109	.622	.8510			10S	.134	5.295	7.770
1¼	1.050	80 80S Ex. Hvy.	.147	.546	1.088	6	6.625	40 40S Est.	.237	4.026	10.79
		160	.187	.466	1.304			80 80S Ex. Hvy.	.337	3.826	14.98
		XX Hvy.	.294	.252	1.714			120	.438	3.624	19.00
1½	1.315	5S	.065	.920	.6838	8	8.625	160	.531	3.438	22.51
		10S	.083	.884	.8572			XX Hvy.	.674	3.152	27.54
		40 40S Std.	.113	.824	1.131			5S	.109	5.345	6.349
1¾	1.660	80 80S Ex. Hvy.	.154	.742	1.474	10	10.750	10S	.134	5.295	7.770
		160	.218	.614	1.937			40 40S Est.	.258	5.047	14.62
		XX Hvy.	.308	.434	2.441			80 80S Ex. Hvy.	.375	4.813	20.78
2	2.375	5S	.065	1.185	.8678	10	10.750	120	.500	4.563	27.04
		10S	.109	1.097	1.404			160	.625	4.313	32.96
		40 40S Std.	.133	1.049	1.679			XX Hvy.	.750	4.063	38.55
2½	2.875	80 80S Ex. Hvy.	.179	.957	2.172	10	10.750	5S	.109	6.407	7.585
		160	.250	.815	2.844			10S	.134	6.357	9.289
		XX Hvy.	.358	.599	3.659			40 40S Std.	.280	6.065	18.97
3	3.500	5S	.065	1.530	1.107	10	10.750	80 80S Ex. Hvy.	.432	5.761	28.57
		10S	.109	1.442	1.806			120	.562	5.491	36.39
		40 40S Std.	.140	1.380	2.273			160	.718	5.189	45.30
3½	4.000	80 80S Ex. Hvy.	.191	1.278	2.997	10	10.750	XX Hvy.	.864	4.897	53.16
		160	.250	1.160	3.765			5S	.109	8.407	9.914
		XX Hvy.	.382	.896	5.214			10S	.148	8.329	13.40
4	4.500	5S	.065	1.770	1.274	10	10.750	20	.250	8.125	22.36
		10S	.109	1.682	2.085			30	.277	8.071	24.70
		40 40S Std.	.145	1.610	2.718			40 40S Est.	.322	7.981	28.55
4½	5.000	80 80S Ex. Hvy.	.200	1.500	3.631	10	10.750	60	.406	7.813	35.64
		160	.281	1.338	4.859			80 80S Ex. Hvy.	.500	7.625	43.39
		XX Hvy.	.400	1.100	6.408			100	.593	7.439	50.87
5	5.563	5S	.065	2.245	1.604	10	10.750	120	.718	7.189	60.63
		10S	.109	2.157	2.638			140	.812	7.001	67.76
		40 40S Std.	.154	2.067	3.653			160	.906	6.813	74.69
5½	6.063	80 80S Ex. Hvy.	.218	1.939	5.022	10	10.750	5S	.134	10.482	15.19
		160	.343	1.689	7.444			10S	.165	10.420	18.70
		XX Hvy.	.436	1.503	9.029			20	.250	10.250	28.04
6	6.625	5S	.065	2.709	2.475	10	10.750	30	.307	10.136	34.24
		10S	.120	2.635	3.531			40 40S Std.	.365	10.020	40.48
		40 40S Est.	.203	2.469	5.793			60 80S Ex. Hvy.	.500	9.750	54.74
6½	7.125	80 80S Ex. Hvy.	.276	2.323	7.661	10	10.750	80	.593	9.564	64.33
		160	.375	2.125	10.01			100	.718	9.224	76.93
		XX Hvy.	.552	1.771	13.69			120	.843	9.064	89.20
7	7.625	5S	.065	3.000	2.850	10	10.750	140	1.000	8.750	104.1
		10S	.109	2.912	3.906			160	1.125	8.500	115.7
		40 40S Est.	.145	2.824	4.962						

NOTE:
Weights shown are in pounds per foot, based on the average wall of the pipe. The following formula was used in calculating the weight per foot.

W = 10.68 (D - t)t
W = Weight in pounds per foot (to 4 digits)
D = Outside Diameter in inches (to 3 decimal places)
t = Wall thickness in decimals (to 3 decimal places)

All weights are carried to four digits only, the fifth digit being carried forward if five or over, or dropped if under five.

The most common types of drives for Screw Conveyors are illustrated below.

In addition to those shown, other types available are: variable speed drives, hydraulic drives, and take-off drives for connection to other equipment.

For special drive requirements, consult our Engineering Department.

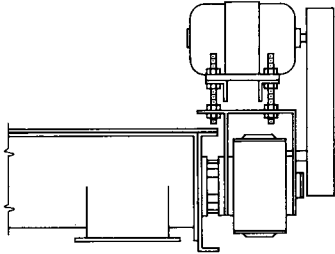
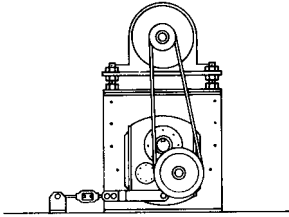
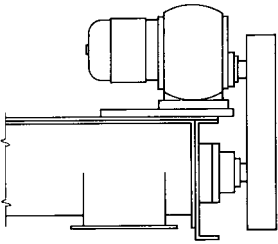
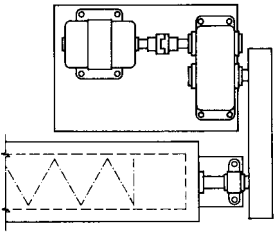
<p>Screw Driver Reducer</p>	 <p>(Side View)</p>	<p>Reducer mounts on trough end, and is directly connected to the conveyor screw and includes integral thrust bearing, seal gland, and drive shaft. Motor mount may be positioned at top, either side, or below. Separate drive shaft, end bearing, and seal are not required.</p>
<p>Shaft Mounted Reducer</p>	 <p>(End View)</p>	<p>Reducer mounts on conveyor drive shaft. Motor and "V"-Belt drive may be in any convenient location. The torque arm may be fastened to the floor, or fitted to trough end. Requires extended drive shaft, end bearing, and seal.</p> <p>Note: Requires thrust unit or collars to hold thrust.</p>
<p>Gearmotor Drive</p>	 <p>(Side View)</p>	<p>Integral motor-reducer with chain drive to conveyor drive shaft. Usually mounted to top of trough by means of an adapter plate.</p>
<p>Base Type Reducer Drive</p>	 <p>(Top View)</p>	<p>Motor direct-coupled to base type reducer, with chain drive to conveyor drive shaft. Usually mounted on floor or platform as close as possible to conveyor.</p>

Helicoid Screw Conveyors

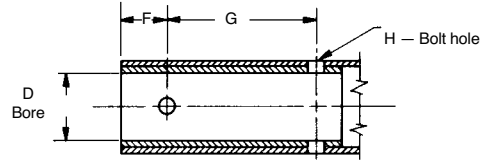
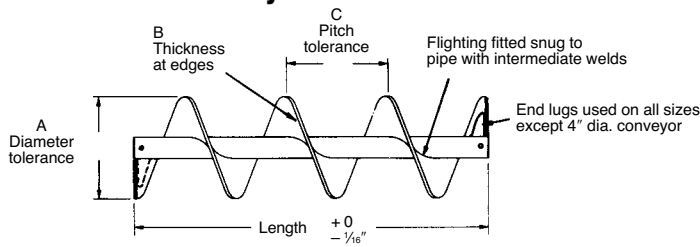

Listed Screw Diameter and Pitch	Coupling Diameter	Size Designation	Pipe Size Schedule 40	Length Feet and Inches	A		B		C		D		F	G	H
					Diameter Tolerance		Thickness		Pitch Tolerance		Bushing Bore Inside Diameter		Spacing 1st Bolt Hole	Centers 2nd Bolt Hole	Nominal Bolt Hole Size
					Plus	Minus	Inner Edge	Outer Edge	Plus	Minus	Minimum	Maximum			
4	1	4H206	1¼	9-10½	⅙	⅙	⅜	⅜	½	¼	1.005	1.016	½	2	1⅜
6	1½	6H304	2	9-10	⅙	⅜	⅜	⅜	½	¼	1.505	1.516	⅞	3	1⅞
6	1½	6H308	2	9-10	⅙	⅜	¼	⅜	¾	¼	1.505	1.516	⅞	3	1⅞
6	1½	6H312	2	9-10	⅙	⅜	¾	⅜	¾	¼	1.505	1.516	⅞	3	1⅞
9	1½	9H306	2	9-10	⅙	⅜	⅜	⅜	¾	¼	1.505	1.516	⅞	3	1⅞
9	1½	9H312	2	9-10	⅙	⅜	¾	⅜	¾	¼	1.505	1.516	⅞	3	1⅞
9	2	9H406	2½	9-10	⅙	⅜	⅜	⅜	¾	¼	2.005	2.016	⅞	3	2⅜
9	2	9H412	2½	9-10	⅙	¼	¾	⅜	¾	¼	2.005	2.016	⅞	3	2⅜
9	2	9H414	2½	9-10	⅙	¼	⅞	⅜	¾	¼	2.005	2.016	⅞	3	2⅜
10	1½	10H306	2	9-10	⅙	⅜	⅜	⅜	¾	¼	1.505	1.516	⅞	3	1⅞
10	2	10H412	2½	9-10	⅙	¼	¾	⅜	¾	¼	2.005	2.016	⅞	3	2⅜
12	2	12H408	2½	11-10	⅙	⅜	¼	⅜	1	¼	2.005	2.016	⅞	3	2⅜
12	2	12H412	2½	11-10	⅙	⅜	¾	⅜	1	¼	2.005	2.016	⅞	3	2⅜
12	2½	12H508	3	11-9	⅙	⅜	¼	⅜	1	¼	2.443	2.458	1⅞	3	2⅜
12	2½	12H512	3	11-9	⅙	⅜	¾	⅜	1	¼	2.443	2.458	1⅞	3	2⅜
12	3	12H614	3½	11-9	⅙	¾	⅞	⅜	1	¼	3.005	3.025	1	3	2⅞
14	2½	14H508	3	11-9	⅙	⅜	¼	⅜	1	¼	2.443	2.458	1⅞	3	2⅜
14	3	14H614	3½	11-9	⅙	¾	⅞	⅜	1	¼	3.005	3.025	1	3	2⅞
16	3	16H610	3½	11-9	⅙	¾	⅞	⅜	1½	¼	3.005	3.025	1	3	2⅞
16	3	16H614	4	11-9	⅙	¾	⅞	⅜	1½	¼	3.005	3.025	1	3	2⅞

NOTE: All dimensions in inches.

Cut Flight/Cut & Folded Flight Conveyors

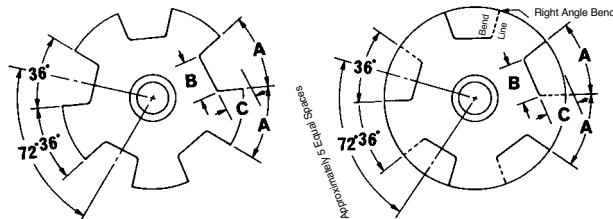

Depth of cut "C" is one half the flight width for normal maximum pipe size. Lengths "A" and "B" are calculated from the developed O.D. for standard pitch.

Screw Diameter	A	B	C
4	1⅜	1	⅝
6	2	1½	⅞
9	3	2½	1½
10	3⅜	2¼	1¾
12	4	2¼	2
14	4⅝	3⅞	2½
16	5¼	3½	3
18	6	3⅞	3⅞
20	6⅝	4¼	3⅞
24	7⅞	4⅞	4⅞

